



Custom Installation Guide



The Absolute **Best Lifetime Ownership** Experience.



The options are endless...

Contents

Transform Your Backyard	5
Basic Installation Considerations	6
Installation Possibilities	8
Custom Cabinet Spa	10
Partially-Recessed Spa	14
Fully-Recessed Spa	20
Access Information	24
Planning Checklist	25
Owner Satisfaction	26

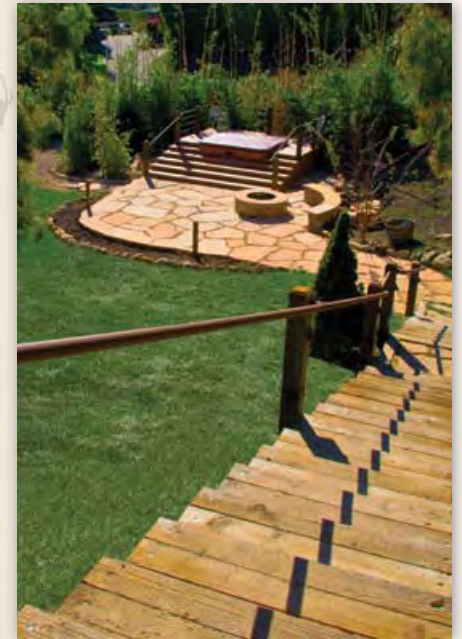





Transform Your Backyard

Your Hot Spring® spa can be seamlessly integrated into your backyard to create a landscape masterpiece.

Custom Installation Guidelines

- If you plan to recess your new Hot Spring spa in a deck, patio, or other hardscape element, please take the time to read this guide carefully. It provides you with installation ideas, planning information, and recommendations needed to ensure the safe, secure, and timely installation of your new spa.
- This guide also provides you with the information needed to ensure that access to your spa for maintenance and operational reasons will not become problematic in the future. Providing this access is the homeowner's responsibility.
- You will also want to carefully read your spa's Owner's Manual and Pre-Delivery Instructions in conjunction with this guide. These documents can be found online at www.hotspring.com in the Owners Corner section.

Conventions Used in this Guide



NOTE: A note is useful information, but is not mandatory for your spa installation.



IMPORTANT: This information is necessary to properly prepare for your spa installation, maintenance, and usage. Important information is placed strategically within this document to help you prevent avoidable expenses after installation is complete.



WARNING: This information warns you about items pertaining to your spa installation that are safety or hazard concerns, as well as actions that may void your spa's warranty.

Basic Installation Considerations

When selecting your spa's location, the following factors should be considered during the planning stage.



NOTE: It is highly recommended to adhere to the information provided so you do not void the warranty of your spa nor incur additional expenses in the unlikely event that plumbing or other repairs are needed.

Location of the electrical connections

Electrical connections to the Equipment Compartment are made through the Electrical Cutout on the front side of the spa. If you are planning on a partially- or fully-recessed spa installation that covers the Electrical Access Panel, service access will need to be provided. This is covered in more detail in the partially-recessed and fully-recessed sections of this document.

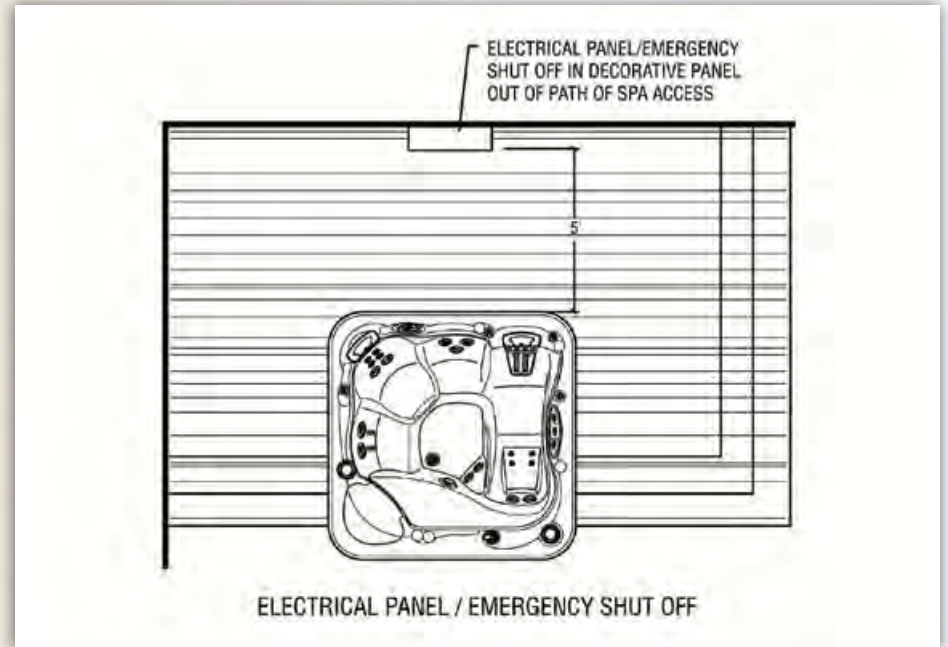
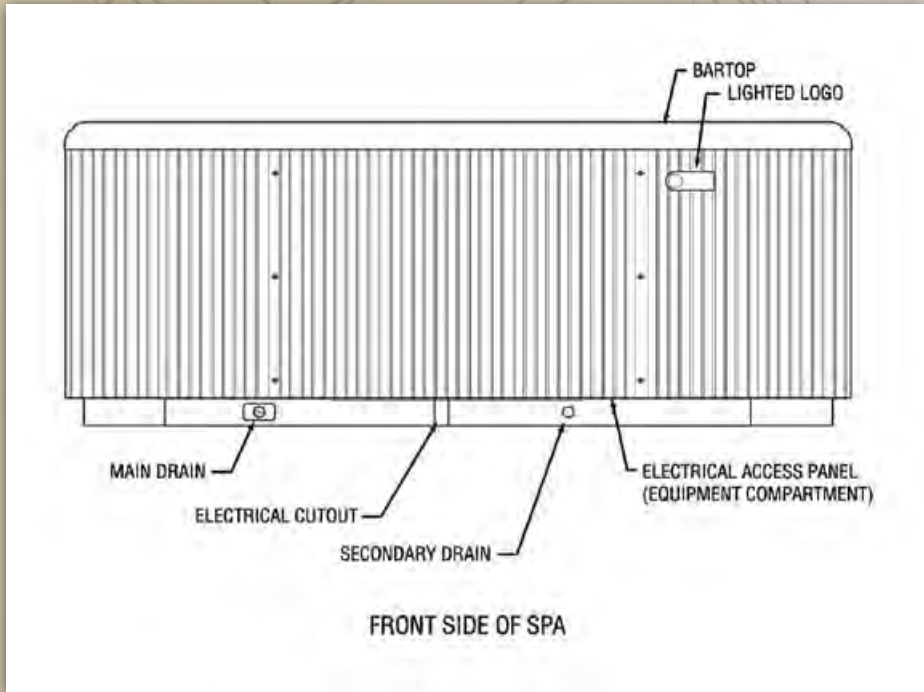

Location of the subpanel

For spas that require 230v, a subpanel is provided with the Hot Spring® spa. The subpanel is an intermediate electrical connection box between your home's electrical panel and the spa. The subpanel houses the spa's circuit breakers, which you will need to access when draining and cleaning your spa. Typically, the subpanel needs to be 5 feet to 50 feet away from the spa and visible from the spa, as shown in the diagram above. Be sure to check local electrical codes when planning the location of your subpanel.

Type of structural support

For any type of installation, the spa needs to sit on a concrete slab.

Drain locations of spa

Ensure that there is access to the drain locations pictured in your spa's Pre-Delivery Guide (an example is shown below). Regular maintenance of your spa requires draining the water approximately every 4 months. The location you choose for your spa needs to allow for this water to drain away from the spa and any other structures, landscape or hardscape that could be negatively impacted by water flow. Please note that during transportation, the spa's drain caps are removed and placed in the owner's packet. This prevents stagnant water from remaining within the system for long periods of time. Ensure that these drains are capped prior to installing your spa into your deck or patio.

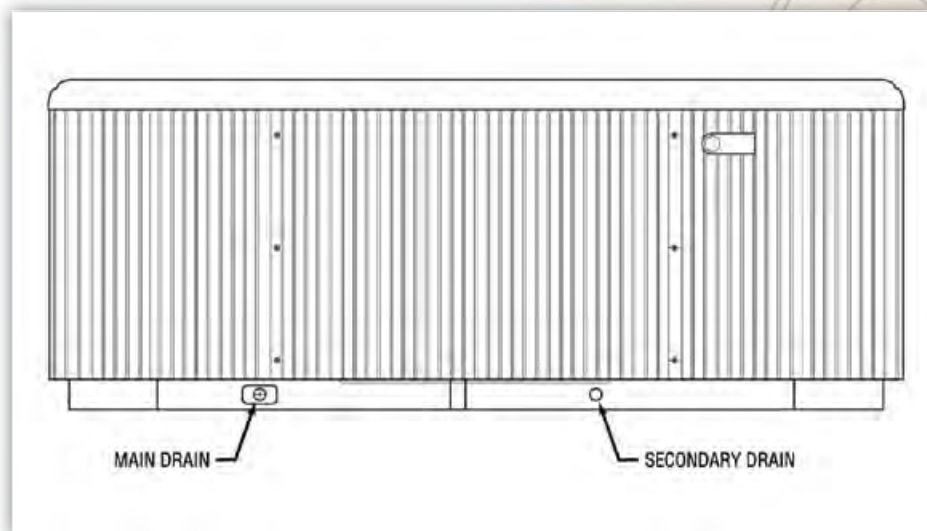

Drainage for excess water around spa

For all types of installations, ensure any exterior water will drain away from the spa. Standing water around a spa can be dangerous, especially if the water rises to the equipment compartment level. Select the location of your spa with the possibility of standing water/drainage in mind.

Access to side and back panels for plumbing or lighting repairs

In the unlikely event of an internal plumbing or lighting problem, it is necessary to have access to the side and back panels in order to make repairs. In any recessed application, access to internal plumbing components requires a minimum of 24 inches of clearance around the entire spa. In some rare cases, the spa may need to be removed from the installation site entirely, depending on the type of installation and complexity of repair required. Utilizing a trapdoor/access panel can be

an easy way to accomplish this goal. This is covered in more detail in the partially-recessed and fully-recessed sections of this document

Cover locks

Cover locks or some form of safety barrier are required by law. All spas must include a locking device (typically a cover with cover locks) to ensure the safety of family, pets and friends. Depending on the installation, you and your landscape contractor will need to consider a method to lock your spa cover.



Installation Possibilities

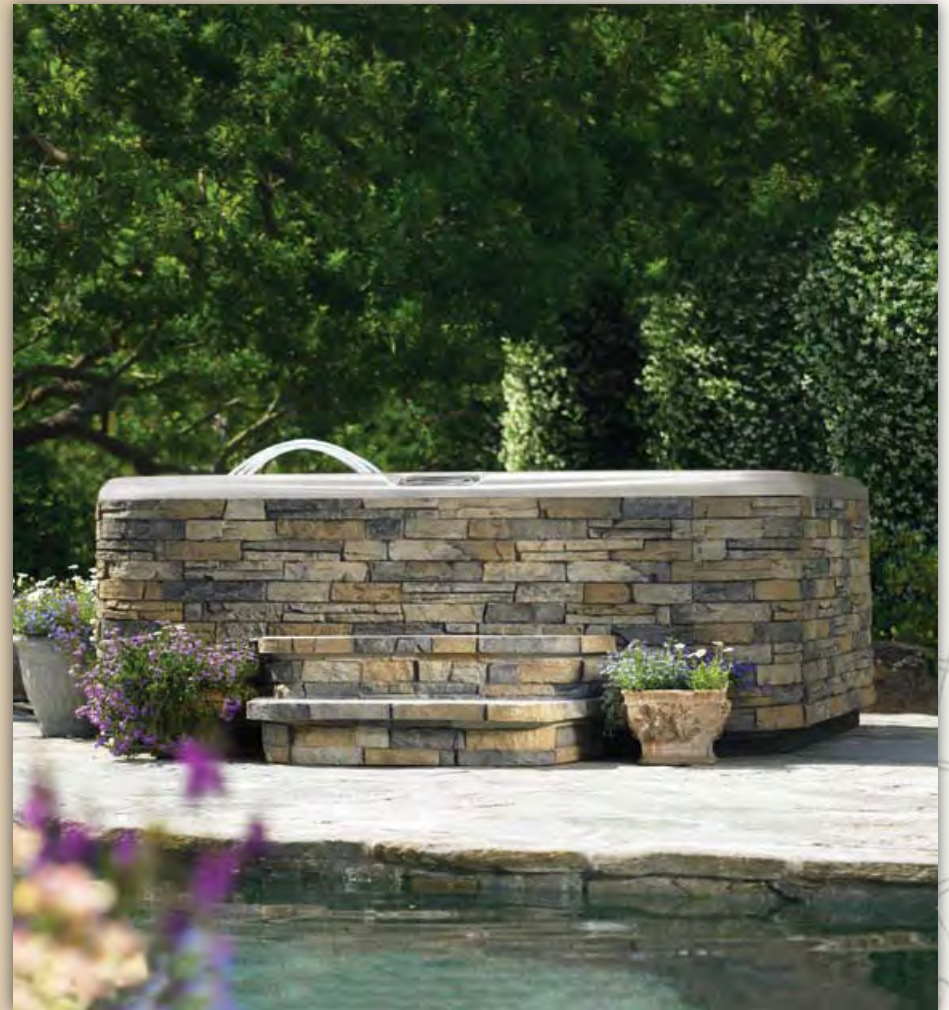

Custom Cabinet Spa

Hot Spring® Custom Cabinet spas are specifically designed to be surrounded by any style of exterior surface to blend with your outdoor environment.



Partially-Recessed Spa

A partially-recessed spa is installed into a deck or patio with some combination of sides recessed.



Fully-Recessed Spa

A fully-recessed spa is installed such that the deck or patio conceals the spa cabinet.

Custom Cabinet Spa

With Hot Spring® Custom Cabinet spa models, it's easy to seamlessly integrate a portable spa into your surroundings. Hot Spring Custom Cabinet spas are specifically designed to be surrounded by any style of exterior surface to blend with your outdoor environment. Work with your landscape architect to surround your Custom Cabinet spa with whatever exterior you desire, or simply add a Hot Spring partial or full SpaStone® surround to give the beauty of a natural-stone look. With the Custom Cabinet spa option, the possibilities are endless.



NOTE: Only the Vista®, Grandee®, Aria®, and Vanguard® models are available as Custom Cabinet spas.



IMPORTANT: Your Custom Cabinet spa can be fully-recessed, partially-recessed or not recessed at all. Whatever installation is selected, the exposed portion of the Custom Cabinet spa can then be “decorated” in whatever style and with whatever material you desire. If you plan on partially- or fully-recessing your custom cabinet spa, please refer to the sections on partially- and/or fully-recessed spa installations on pages 14 and 20, respectively.



For example, go from this...



...to this.





CUSTOM CABINET INSTALLATION CONSIDERATIONS



IMPORTANT: Please refer to the BASIC SPA INSTALLATION CONSIDERATIONS section beginning on page 6 for details on the location of the electrical connections, equipment compartment, drains, etc.

Choosing an Exterior

Custom Cabinet spas are shipped with 3/4 inch, sealant-treated BCX plywood sheets that cover the spa's inner structure, plumbing, and electrical components. The plywood façade provides a solid surface to which a Hot Spring SpaStone surround or a custom siding can be attached. Vertical supports beneath the plywood provide additional support for heavier materials (such as flagstone) that may be attached to the plywood.

Hot Spring® SpaStone® Surround

For a solution tailored specifically for your Hot Spring spa, select a full or partial SpaStone surround, available in two color choices.

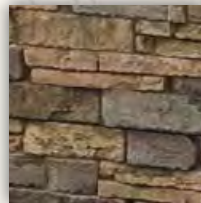

Earth

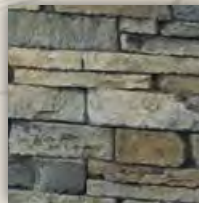

Gray

Your Hot Spring dealer can provide specifications and dimensions for the Hot Spring SpaStone options.

Custom Siding Ideas

Use an exterior covering for your custom cabinet spa such as faux brick, faux slate rock, teakwood, aluminum, brushed steel, etc. to create your own look.



Custom Cabinet Spa *(continued)*

Attaching a Custom Siding

When attaching alternate types of siding to a Custom Cabinet spa, plan on using drywall or deck screws. Be sure to use the correct-length screw applicable to the depth of the custom exterior selected.

For example, if the siding of choice is approximately 3/4 inch to 1 inch thick, it is best to use a 2 inch screw so that the exterior siding and custom cabinet plywood protection on the spa can be penetrated. Using the correct-length screw ensures that the internal spa workings will not be harmed. In addition, the vertical supports (shown to the right) surrounding your spa can be used as attachment points for any custom exterior siding, if needed.



NOTE: Remember to provide access on all sides of the spa in case repairs are needed. If you choose to create a unique siding, you may want to mount the siding on sheets of plywood which can then be fastened to the spa exterior. Access to the spa's internal components would then be achieved by removing one of these custom panels. This method would save time and expense in the event of a repair.



WARNING: On a Vista® or Grandee® Custom Cabinet spa, a 2 inch screw is the maximum screw length to use. On an Aria® or Vanguard® Custom Cabinet spa the maximum screw length is 2 1/2 inches. Using a screw other than those specified could damage the functionality of the spa and would void the spa's warranty.



IMPORTANT: Be sure to discuss hardware/screw length with your landscape contractor when planning for your custom spa siding installation.

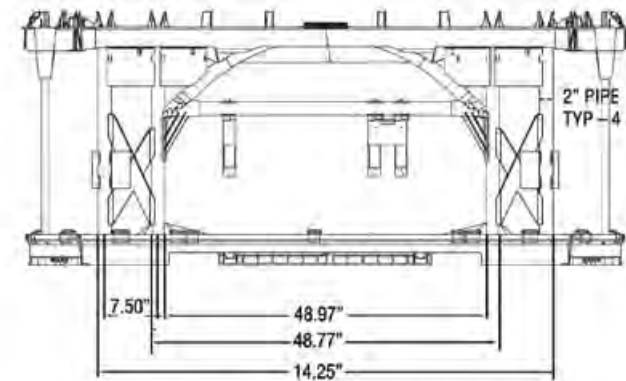

FRAME FRONT SIDE ASSEMBLY

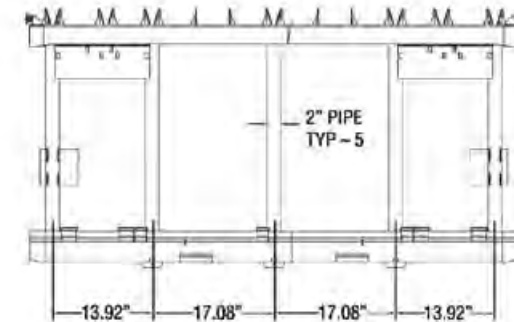

FRAME SIDE ASSEMBLY

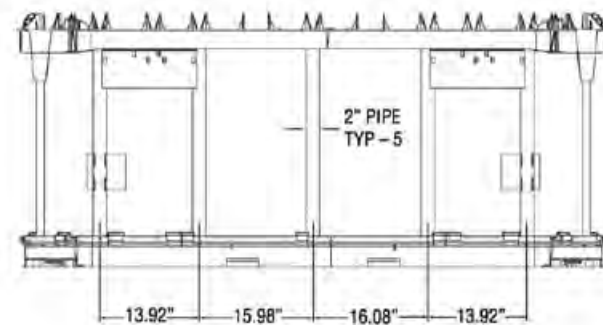

FRAME BACK SIDE ASSEMBLY

Aria / Vanguard

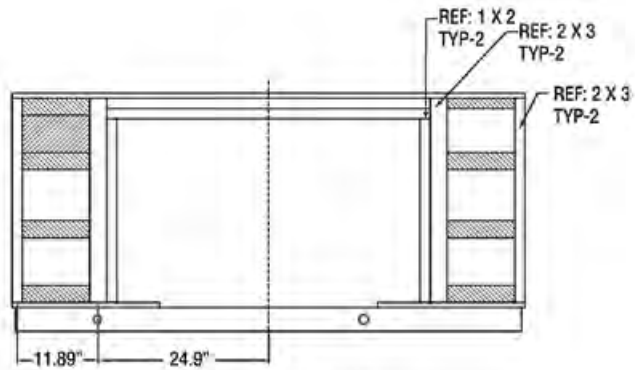

FRAME FRONT SIDE ASSEMBLY

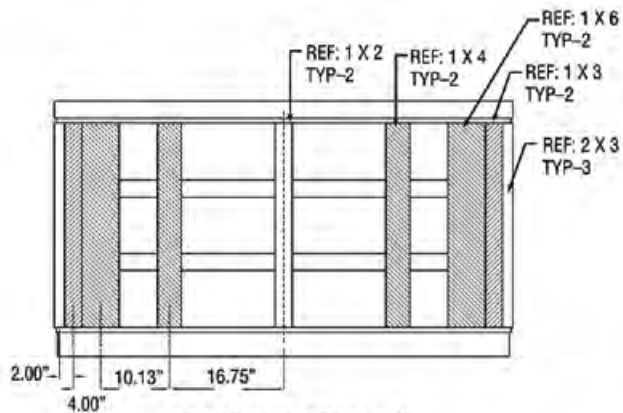

FRAME SIDE ASSEMBLY

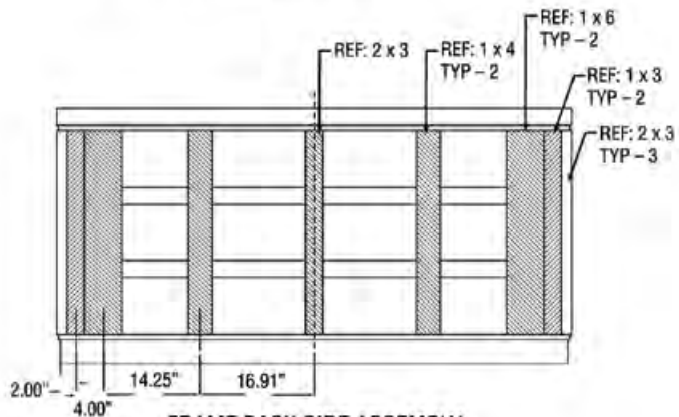

FRAME BACK SIDE ASSEMBLY

Vista / Grandee



Cover lifters

A cover lifter allows for easy opening/closing of your spa cover. Cover lifters are easily installed in conjunction with the SpaStone® product. You can also use a cover lifter with a custom exterior covering. Just ensure that the top/bartop of the exterior covering is designed in a way that allows for the cover, AND fits with the dimensions of a standard cover lifter. Talk to your authorized Hot Spring® spa dealer for more information regarding spa cover lifters.

Cover locks

Cover locks or some form of safety barrier are required by law. All spas must include a locking device (typically a cover with cover locks) to ensure the safety of family, pets, and friends. Depending on the installation, you and your landscape contractor will need to consider a method for locking your spa cover.



IMPORTANT: Some form of safety barrier is required by law. If cover locks are not feasible with your particular installation, you will need to install a gate or fence (similar to a pool) in order to provide a barrier for your Hot Spring spa. Please check your local building codes.

Drainage

When selecting the location for your custom exterior spa, ensure that water will not puddle around the spa. Provide a drainage system where the water flows down and away from the spa to an appropriate outlet or drain.

Partially-Recessed Spa

A partially-recessed spa is one where the deck or patio begins somewhere between the top and the base of the spa or where some combination of sides are recessed. It can fit nicely into your deck or patio, allowing for easy access to the electrical equipment and drains.



NOTE: ALL models of Hot Spring® spas can be partially-recessed.

PARTIALLY-RECESSED INSTALLATION CONSIDERATIONS



IMPORTANT: Please refer to the BASIC SPA INSTALLATION CONSIDERATIONS section beginning on page 6 for details on the location of the electrical connections, equipment compartment, drains, etc.



NOTE: When partially-recessing a Hot Spring Custom Cabinet spa it is important to leave access to any exposed plywood that is below the deck or patio level, as periodically treating the exposed areas of the plywood siding is recommended.

Safe entry and exit

Easy and safe access are important when entering and exiting your spa.



WARNING: Safe entry is especially crucial in a partially-recessed environment, because you are stepping down into the spa. Installing a handrail will assist with safe footing. Hot Spring offers a Spa Side Handrail developed for the spa environment. Or, custom handrails can be constructed at the entry point of the spa by a qualified, licensed contractor applying local building and construction codes.



NOTE: The Hot Spring handrail swings inward or outward for both in and out of spa use. A baseplate slips securely under the spa, and the handrail comes up through an opening in the patio or decking.





Cover lifters

A cover lifter allows for the easy opening and closing of your spa cover. The UpRite® cover lifter is easily installed in conjunction with the SpaStone® partial-surround cabinet. This cover lifter stands the cover straight up behind the spa so as not to interfere with the decorative ledge of the SpaStone partial surround cabinet.



 **NOTE:** If you have maintained a 24 inch service space around your entire spa, you will have no difficulty storing the spa cover behind the spa, since you only need to maintain a minimum of 10 inches of space behind the spa to accommodate the thickness of the cover. If there is at least 16 inches of clearance between the top of your spa and the decking or patio, 10 inches between your spa and the nearest wall, and you are not using the SpaStone partially-recessed surround cabinet, then the Lift 'n Glide® cover lifter is also an option.

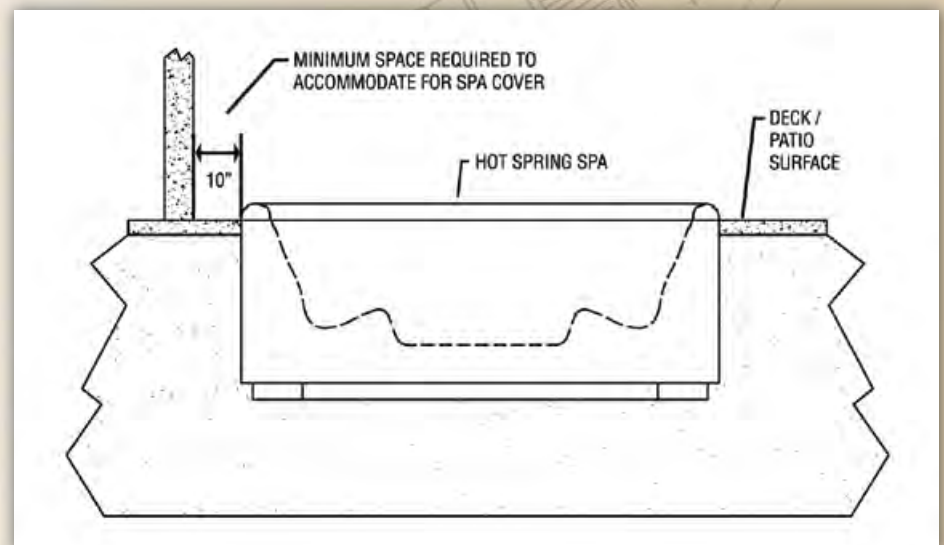

Partially-Recessed Spa *(continued)*

Cover locks

Cover locks or some form of safety barrier are required by law. All spas must include a locking device (typically a cover with cover locks) to ensure the safety of family, pets, and friends. Depending on the installation, you and your landscape contractor will need to consider a method for locking your spa cover.

When planning your partially-recessed spa within a deck or patio surrounding, if the length of the cover straps require that the locks be positioned below deck or patio level, provide cutouts at each corner of the spa to allow access (for your hand in order to lock/unlock the cover locks) between the deck/patio surrounding the spa.

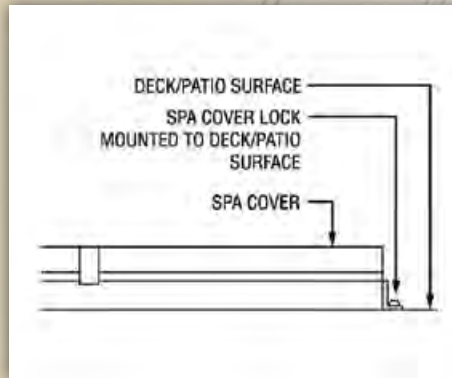
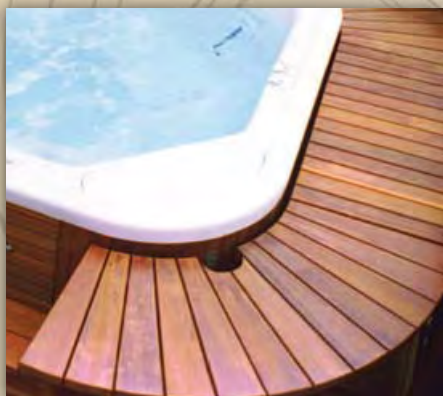

Or, provide four recessed points in the deck at each corner of the spa. Mount the locking portion of the clip inside the recessed points. Be sure to measure the distance from the cover to the end of the male cover clip to determine how far away to install the recessed cover locks.

 **NOTE:** If the above suggestions are not possible, you need to provide proper safeguards required by local codes and regulations to prevent unwanted access to your spa. These safeguards may include, but are not limited to, security enclosure fencing and exterior doorway alarms.

Creating Access

It's important to create easy access to the equipment compartment, internal plumbing and lighting components. The spa's equipment compartment is on the front side of the spa (see diagram below). The following are several suggested options.

Option 1:

Design your partially-recessed installation so that the front side of the spa is exposed, providing access, while the decking/patio covers the remaining two or three sides of your spa. (See image to the right. Steps are removable, providing access to the front panel.) Then, to provide access to the internal plumbing and lighting, install access panels along the sides and back of the spa. These access panels should be the length of the sides and be 24 inches wide (large enough to enable someone to drop into the opening and work on the spa).

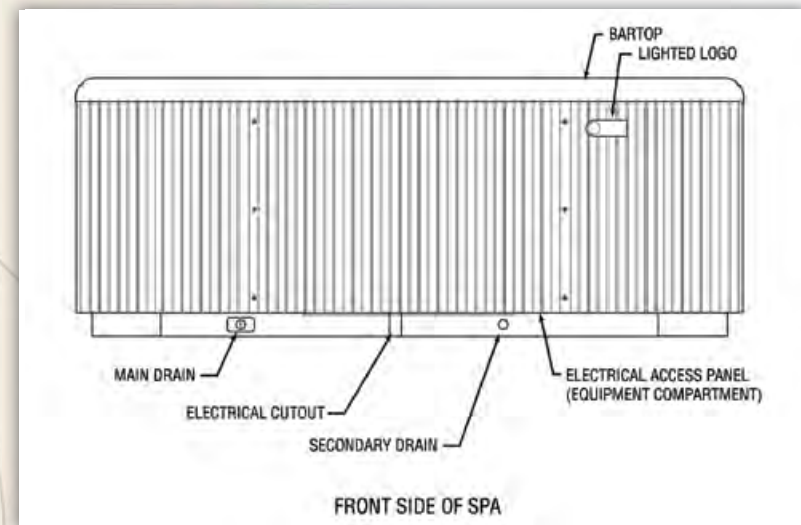



Option 2:

Design a removable or hinged access panel for all sides of the spa. The access panel in the decking at the front side of the spa will provide access to the equipment compartment. The access panel should run the width of the spa and provide enough space for someone to drop through the opening and safely work with the electrical equipment. In some states, electrical codes require a 36 inch area in order to safely work on electrical equipment (36 inches being the dimension between the spa and the decking when the access panel is removed or opened).

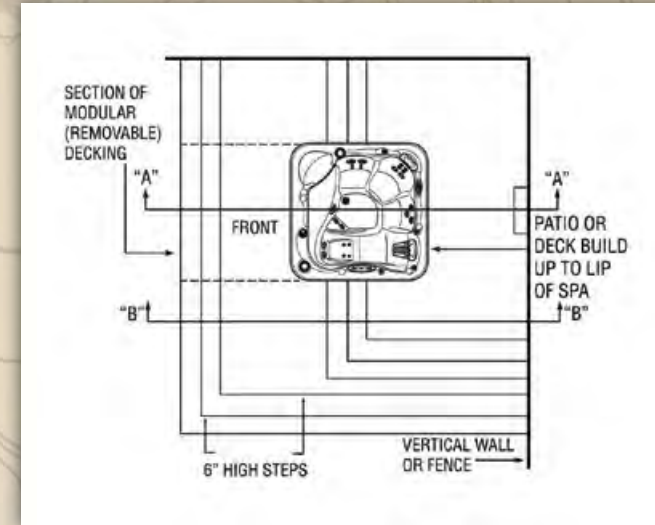

NOTE: Please check your state's electrical codes.

Option 3:

If you are partially recessing a Custom Cabinet spa that will have a unique siding, please refer to the custom spa section of this guide for the locations of the support structure. However, the preferred method for creating a custom environment for your Custom Cabinet partially-recessed spa is to simply build around it, rather than attach material directly to the body of the Custom Cabinet spa. You or a qualified landscape contractor can plan for and create a structure that would allow you to attach any type of siding to that structure. Then, the Custom Cabinet spa could be placed inside this customized structure, similar to a fully-recessed spa installation.

Partially-Recessed Spa *(continued)*



Drainage

There are two scenarios for a partially-recessed spa. The first is a spa that is recessed into a raised deck, where the spa sits above grade on a cement pad. The second is a spa that actually sits below grade and is surrounded by ground-level decking or a patio.

Scenario 1:

Assumes that the spa is above grade. When selecting the location for your spa, ensure that water will not puddle around the base of the spa. Consider a drainage system in which the water flows down and away from the spa to an appropriate outlet or drain.

Scenario 2:

Assumes that some portion of the spa is below grade. An installation below grade requires careful planning. Since water flows downhill and water tables tend to rise, it's important to install your spa in a way that will protect it from rising water levels. At a minimum, a drainage system should be installed. If you live in an area that is prone to high water tables or flooding, a sump pump should be considered.

The optimal solution for this type of installation is a vault. Placing the spa in a vault will allow access to all equipment and components. Access panels in the decking or patio will be needed. The diagram below shows an example of a fully-recessed spa within a vault; similar considerations are important for a partially-recessed spa. Be sure to follow local codes and laws when designing for your partially-recessed spa.



NOTE: If the base of the spa is located either below an appropriate outlet/drain or in a vault-type location, then a sump pump is necessary.

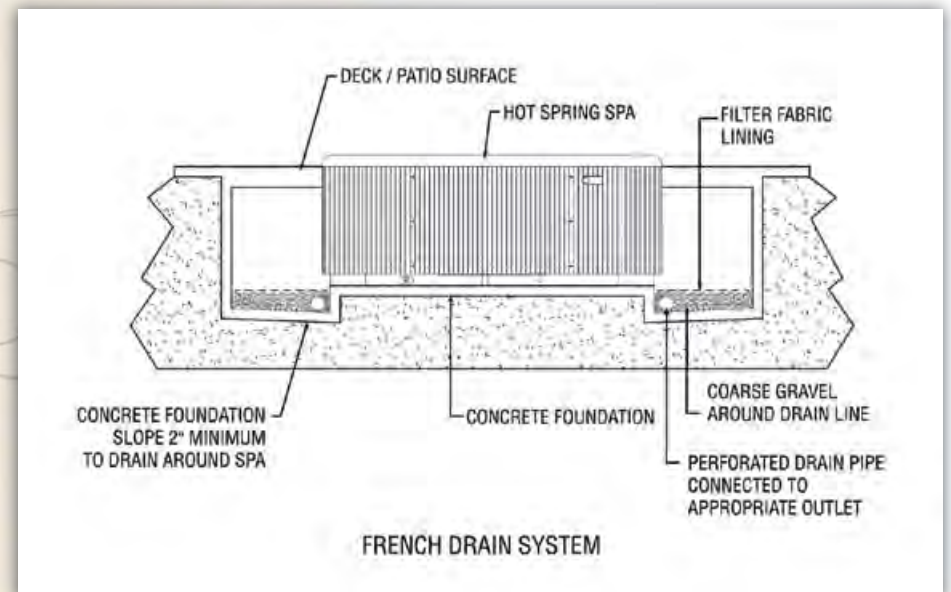



Removal

It is best to plan for potential removal at the time of installation. There are a few options to consider.

Option 1:

Construct your partially-recessed patio or decking so that the entire front face of the spa is exposed. This will allow movers to slide the spa out of the surrounding decking or patio surface (also see concrete pad diagram below).

Option 2:

Construct a modular decking system that allows you to remove sections of your decking to enable the spa to slide out (also see concrete pad diagram below).

Option 3:

If your spa is installed in a vault or your decking cannot be constructed to accommodate removal, a crane can be used to remove the spa. In preparation for removal, even if a crane is not required, it's good practice to pour a concrete pad with removal of the spa in mind. When planning the foundation for your spa, lay two 2' x 6's in the wet concrete to form recesses as shown below. These recesses create two strap slots. Straps can then be snaked underneath the spa in the unlikely event that the spa must be completely removed for repairs.



IMPORTANT: BE SURE TO REMOVE THE 2' x 6's BEFORE THE CONCRETE DRIES.

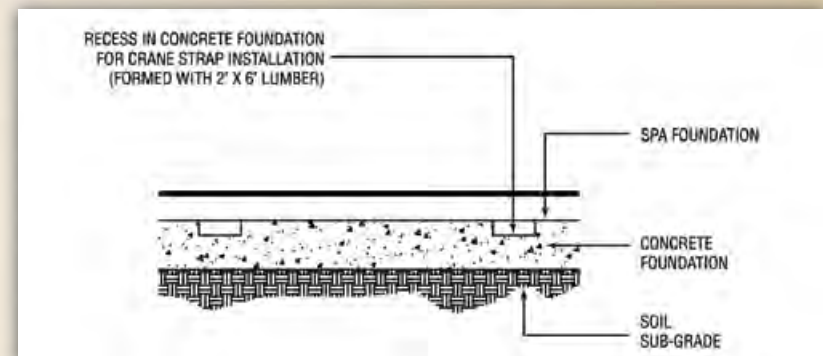



Fully-Recessed Spa

A fully-recessed spa is an in-ground installation where the spa is fully-recessed in the deck or patio, concealing the spa cabinet, electrical equipment and drains. This provides an attractive, fully integrated installation.



NOTE: All models of Hot Spring® spas can be fully-recessed.



NOTE: A fully-recessed spa, with no bartop exposed, will not work with a Hot Spring spa cover. If this is the installation you are planning, please talk to your Hot Spring dealer for more information and options for covers on a fully-recessed spa.



FULLY-RECESSED INSTALLATION CONSIDERATIONS



IMPORTANT: Please refer to the BASIC SPA INSTALLATION CONSIDERATIONS section beginning on page 6 for details on the location of the electrical connections, equipment compartment, drains, etc.

There are two slightly different definitions of the term fully-recessed. The first is when a spa is recessed into a deck or patio with only its bartop (see diagram on page 6 for the location of the bartop) exposed. The second is when a spa is recessed into a deck or patio without ANY of the bartop exposed. In this case, the spa is flush with the top of the deck or patio.

If you want to fully recess your spa into a deck or patio, we recommend the first definition. Why? Because by leaving the bartop exposed above the deck or patio level, you are able to use a Hot Spring cover. The Hot Spring cover

provided with your spa is insulated, meaning less energy is required to keep your spa at the preferred temperature.

The following addresses possible installation considerations and provides you with information as well as recommendations and solutions for you and your installation team to help guide you in the planning and installation of your fully-recessed Hot Spring spa.



NOTE: When fully-recessing a Hot Spring Custom Cabinet spa it is important to leave access to any exposed plywood that is below the deck or patio level, as periodically treating the exposed areas of the plywood siding is recommended.



Safe entry and exit

Easy and safe access are important when entering and exiting your spa. This is particularly crucial in a fully-recessed environment because you are stepping down into the spa. Installing a handrail will assist with safe footing. Hot Spring® Spas offer a Spa Side Handrail developed for the spa environment. Or, custom handrails can be constructed at the entry point of the spa by a qualified, licensed contractor applying local building and construction codes.



NOTE: This Hot Spring handrail swings inward or outward for both in and out of spa use. A base plate slips securely under the spa cabinet, and the handrail comes up through an opening in the patio or decking.



Cover lifters

A cover lifter allows for the easy opening and closing of your spa cover. An UpRite® cover lifter is the recommended solution, as this lifter can be installed on the decking. Because this cover lifter stands your cover straight up behind the spa, it can be used with a fully-recessed spa.



NOTE: If you have elected to disregard the recommendation of leaving a 24 inch service space around your entire spa, a minimum of 10 inches of space is required behind the spa to accommodate the thickness of the cover.

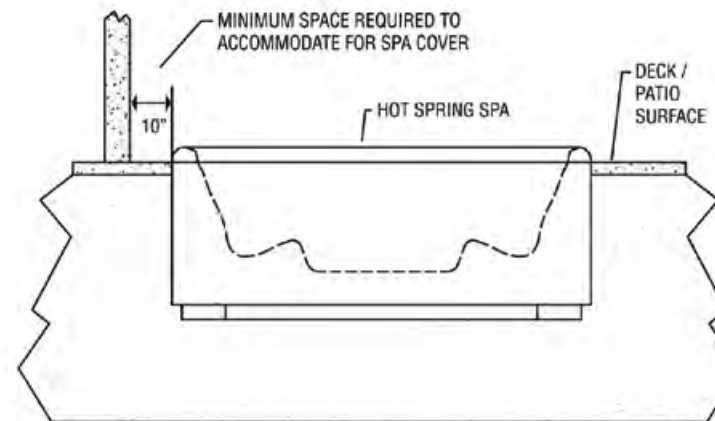

Fully-Recessed Spa *(continued)*

Cover locks

Cover locks or some form of safety barrier are required by law. All spas must include a locking device (typically a cover with cover locks) to ensure the safety of family, pets, and friends. Depending on the installation, you and your landscape contractor will need to consider a method for locking your spa cover.

When planning your fully-recessed spa within a raised deck or patio surrounding, if the length of the cover straps require that the locks be positioned below deck or patio level, provide cutouts at each corner of the spa to allow access (for your hand in order to lock/unlock the cover locks) between the deck/patio surrounding the spa.

Or, if your spa is below grade, provide four recessed points in the deck at each corner of the spa. Mount the locking portion of the clip inside the recessed points. Be sure to measure the distance from the cover to the end of the male cover clip to determine how far away to install the recessed cover locks.



NOTE: If the above suggestions are not possible, you need to provide proper safeguards required by local codes and regulations to prevent unwanted access to your spa. These safeguards may include, but are not limited to, security enclosure fencing and exterior doorway alarms.



Drainage

There are two scenarios for a fully-recessed spa. The first is a spa that is recessed into a raised deck, where the spa sits above grade on a cement pad. The second is a spa that actually sits below grade and is surrounded by ground-level decking or a patio.

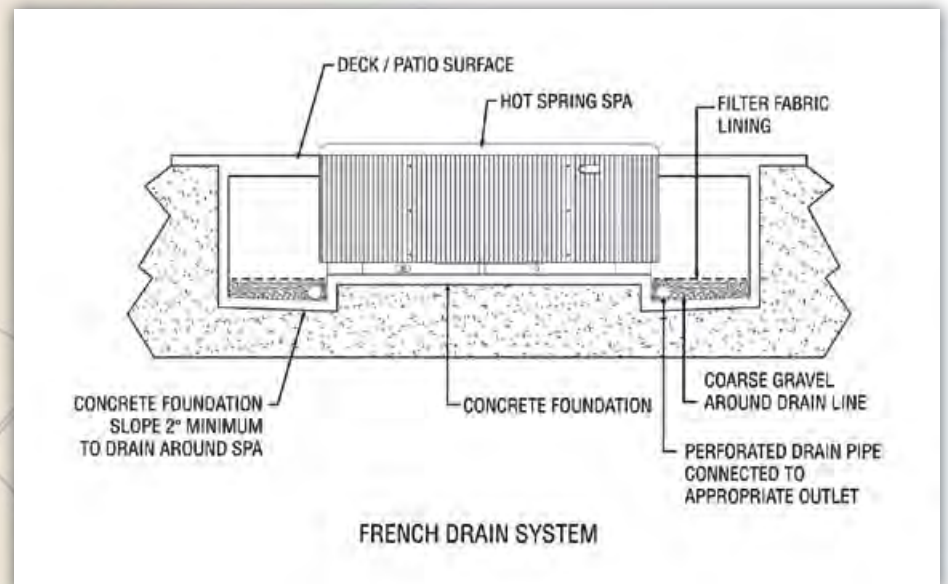



Scenario 1:

Assumes that the spa is above grade. When selecting the location for your spa, ensure that water will not puddle around the base of the spa. Consider a drainage system in which the water flows down and away from the spa to an appropriate outlet or drain.

Scenario 2:

Assumes that the spa is below grade. An installation below grade requires careful planning. Since water flows downhill and water tables tend to rise, it's important to install your spa in a way that will protect it from rising water levels. At a minimum, a drainage system should be installed. If you live in an area that is prone to high water tables or flooding, a sump pump should be considered.

The optimal solution for this type of installation is a vault. Placing the spa in a vault will allow access to all equipment and components. Access panels in the decking or patio will be needed. The diagram to the left shows an example of a fully-recessed spa within a vault. Be sure to follow local codes and laws when designing for your fully-recessed spa.



NOTE: If the base of the spa is located either below an appropriate outlet/drain or in a vault-type location, then a sump pump is necessary.

Removal

It is best to plan for possible removal at the time of installation. There are a few options to consider.

Option 1:

If you are planning to fully-recess your spa into a raised deck, meaning that the spa is actually above grade and the decking is built up around it, you have a few options. First, leave one side of the spa exposed (spa not fully surrounded by the decking). Second, design a modular deck so that portions can be removed in order to remove the spa.

Option 2:

If you are fully recessing your spa below grade, in a vault scenario as shown below, your best option is to plan for removal by crane. In preparation for removal, even if a crane is not required, it's good practice to pour a concrete pad with removal of the spa in mind. When planning the foundation for your spa, lay two 2' x 6's in the wet concrete to form recesses as shown below. These recesses create two strap slots. Straps can then be snaked underneath the spa in the unlikely event that the spa must be completely removed for repairs.



IMPORTANT: BE SURE TO REMOVE THE 2' x 6's BEFORE THE CONCRETE DRIES.

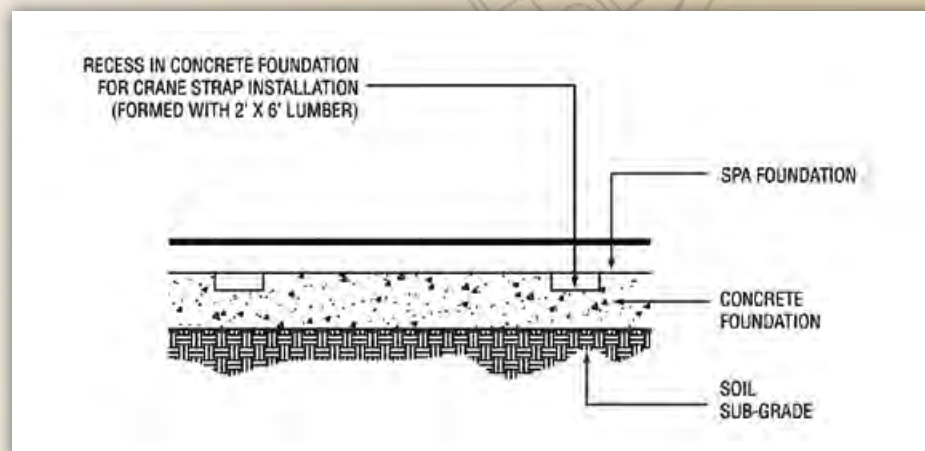

Access Information

Creating access to equipment, plumbing and lighting components

The spa's equipment compartment is on the front side of the unit (see diagram below). To access the equipment compartment or the internal plumbing or lighting components, removable or hinged access panels are needed for all sides of the spa. The access panel in the deck or patio at the front side of the spa will provide access to the equipment compartment. This access panel should run the width of the spa and provide enough space for a person to drop through the opening and safely work with the electrical equipment. Some states' electrical codes require a 36 inch area in order to safely work on electrical equipment (36 inches being the dimension between the spa and the decking when the access panel is removed or open). Access panels at the sides and back of the spa should run the width of the spa and provide enough space for a person to drop through the opening. The standard requirement is a 24 inch work area (24 inches being the dimension between the spa and the decking when the access panel is removed or open).



NOTE: Please check your state's electrical codes.

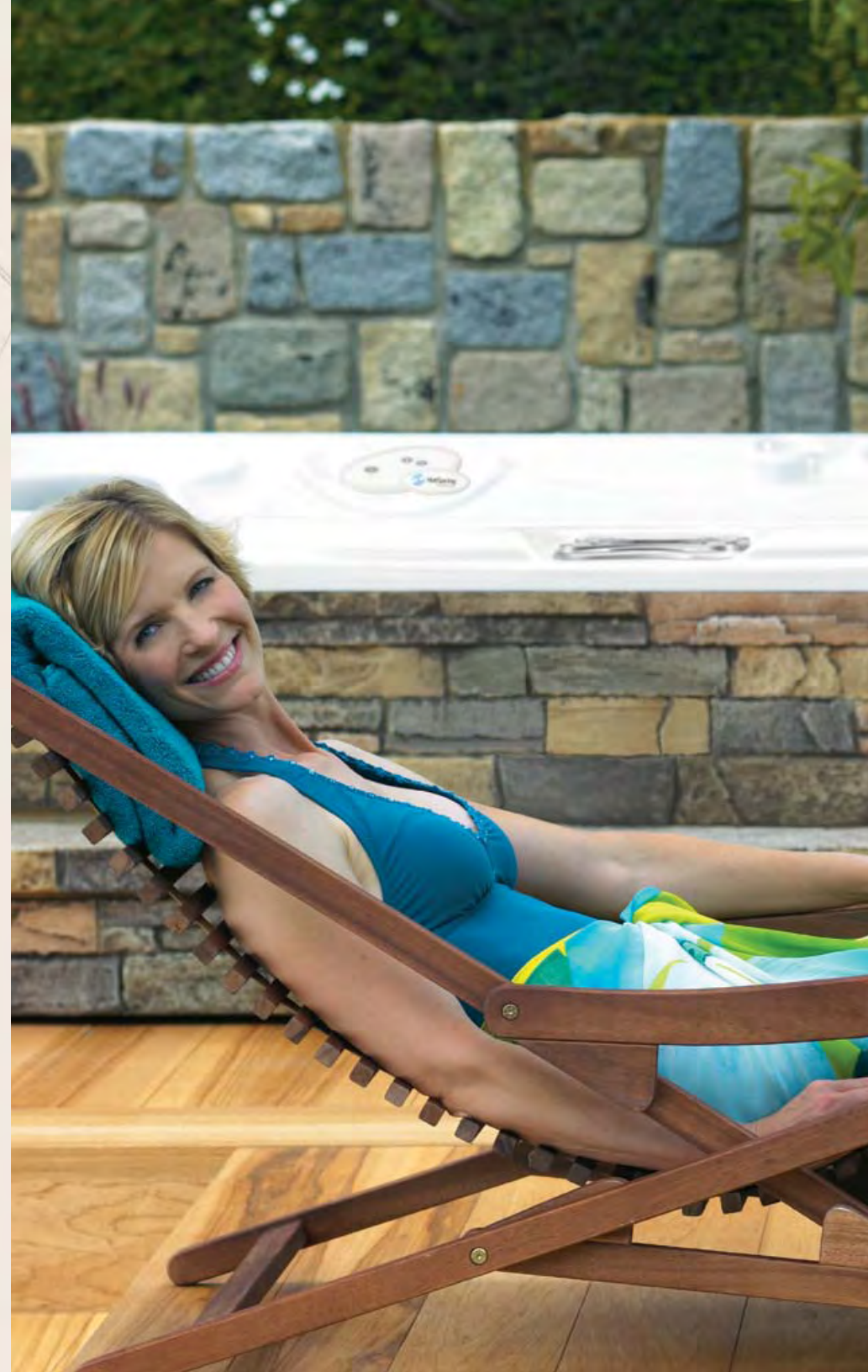
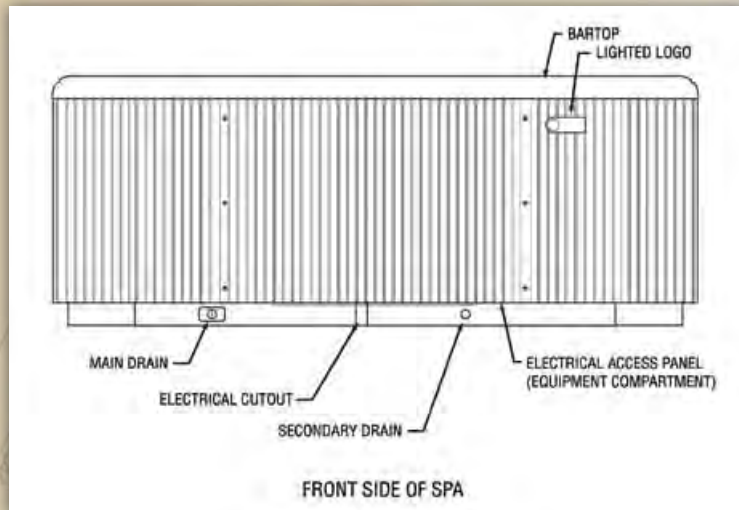



Planning Checklist

To assist you in planning and installing your Hot Spring® spa, the following checklist can be used as a guide to help simplify the overall process. Contact your local Hot Spring dealer as you develop your plans. It may be of value to contact a Landscape Architect/Designer/Contractor to help you create your perfect outdoor solution.

- Review this document to determine which application best suits your needs
- Identify where you would like your spa to be located
- Identify the direction you would like the spa to face
- Identify how to maintain optimum access to all the necessary panels
- Identify from where the electrical will be drawn (contact an Electrical Contractor for installation and to ensure that the electrical installation meets the electrical codes for your area)
- Identify possible locations for the sub-panel (if required)
- Ensure that there will be access to the spa drains and that the water will drain away from the spa or secure a submersible pump for quick draining
- Plan for correct drainage around your spa
- Select a Hot Spring spa model – see your local dealer to select the best model for your application
- Determine what type of cover lifter you would like to use
- Read the Pre-Delivery Instructions
- Fill spa and enjoy!

Owner Satisfaction is Built In

We understand that deciding who to buy from is as important as choosing the hot tub itself – because owning a hot tub means forming a long-term relationship with the manufacturer as well as your local dealer partner.

- As the manufacturer, Hot Spring® honors that relationship by backing every hot tub with solid warranty protection, as well as the finest after-sale customer care.
- We provide ultimate peace of mind by delivering unparalleled service and support in partnership with the world's best independent dealers. There's one located near your home town and in over 800 locations worldwide.
- We are dedicated to ensuring that every Hot Spring spa is built for the reality of daily use and delivers the benefits you want in the most efficient, convenient and reliable manner.

As the world's number one-selling brand, our commitment to advanced engineering and innovation makes Hot Spring spas unsurpassed in functionality, energy-efficiency, and quality. From day in and day out dependability to the absolute lowest operating costs, you will discover that over time, your Hot Spring spa delivers the best value.

We invite you to join the Hot Spring family, and enjoy the absolute best lifetime hot tub ownership experience.







We Print Our Brochures on only Forest Stewardship Council (FSC) Paper
Printed in the USA on recycled paper that contains 10% post-consumer waste and is FSC certified. FSC ensures that the paper in our brochures contains fiber from well-managed and responsibly harvested forests. Please pass this catalog on or recycle again.



The paper in this brochure was manufactured with electricity in the form of renewable energy (wind, hydro, and biogas).

©2009 Watkins Manufacturing Corporation. Specifications, colors, and surface materials subject to change without notice. Vista, Grandee, Aria, Vanguard, IQ 2020, SpaStone, and UpRite are trademarks of Watkins Manufacturing Corporation. Printed in USA.

www.hotspring.com

9/09 PN 62611 Rev B