



LIMELIGHT® COLLECTION

PRISM™ | PULSE® | FLAIR® | FLASH™ | BEAM™

OWNER'S MANUAL





HotSpring®

Every day made better®

Limelight® Collection

**Watkins Wellness® congratulates you on your decision to enjoy the finest spa available...
Welcome to the growing family of HOT SPRING spa owners.**

Before you begin reviewing the manual, please take a moment to register your warranty. Doing so will assist us in contacting you for any important product notification.

Prior to registering, you will need the serial number that is located within the equipment compartment of your **HOT SPRING** spa.

To register please go to <http://www.hotspring.com/hot-tub-owners/hot-tub-product-warranty-registration> or simply scan the QR code below:



FOR YOUR RECORDS

Spa Model/Serial Number: _____

Date Purchased: _____

Dealer: _____

Address: _____

Cover Serial Number: _____

Accessory Serial Number: _____

If you have any questions about any aspect of your spa's set-up, operation or maintenance, contact your authorized **HOT SPRING** dealership. They are trained professionals who are familiar with the product as well as new spa ownership concerns. Their expertise will facilitate the enjoyment of your new **HOT SPRING** spa.

IMPORTANT: WATKINS WELLNESS reserves the right to change specifications, or design, without notification and without incurring any obligation.



In most cities and counties, permits will be required for the installation of electrical circuits or the construction of exterior surfaces (decks and gazebos). In addition, some communities have adopted residential barrier codes which may require fencing and/or self-closing gates on the property to prevent unsupervised access to a pool (or spa) by children under 5 years of age. Your **HOT SPRING** spa is equipped with a locking cover that meets the ASTM F1346-91 Standard for Safety Covers and as a result, is usually exempt from most barrier requirements. As a general practice, your local Building Department will inform you of any applicable barrier requirements at the time a permit is obtained for the installation of an electrical circuit. Your **HOT SPRING** dealer can provide information on which permits may be required.

TABLE OF CONTENTS

SAFETY INFORMATION

IMPORTANT SAFETY INSTRUCTIONS	1
IMPORTANT SPA INSTRUCTIONS	3

GETTING STARTED

SPA FEATURES	4
QUICK START-UP INSTRUCTIONS	5
EQUIPMENT COMPARTMENT	7

WATER QUALITY AND MAINTENANCE

BASIC INFORMATION	8
HOW TO ADD CHEMICALS TO THE WATER	8
FUNDAMENTALS OF WATER MAINTENANCE	9
THE HOT SPRING SPA WATER MAINTENANCE PROGRAM	10
VANISHING ACT INSTRUCTIONS	11
VACATION WATER CARE INSTRUCTIONS	12
WATER TERMINOLOGY	13

OPERATING INSTRUCTIONS

HOME SCREEN	15
TEMPERATURE CONTROL	15
LOCKING FEATURES	15
JETS CONTROL	16
LIGHT CONTROL	16
SUMMER TIMER	16
BRIGHTNESS	17
LANGUAGE	17
AUTO CLEAN CYCLE	17
SOFT WATER CYCLE	17
FRESHWATER [®] SALT SYSTEM (OPTIONAL)	17
AUDIO (OPTIONAL)	17

JET MENUS

PRISM [™] (MODEL PSM)	19
PULSE [®] (MODEL PLS)	20
FLAIR [®] (MODEL FLR)	21
FLASH [™] (FSH)	22
BEAM [™] 220V (BMII)	23
BEAM 115V (BMI)	23

SPA CARE AND MAINTENANCE

DRAIN & REFILL INSTRUCTIONS	24
PREVENTION OF FREEZING	24
FILTER SYSTEM	25
FILTER CARTRIDGES REMOVAL & CLEANING	25
CARE OF THE SPA PILLOWS	25
CARE OF THE EXTERIOR	26
CARE OF THE SPA COVER	26
COVER LIFTER SYSTEM	26

ELECTRICAL REQUIREMENTS

230 VOLT PERMANENTLY CONNECTED MODELS	28
230 VOLT CONVERTED PRISM	29
115 VOLT GFCI BEAM (MODEL BMI)	30
115 VOLT OPERATION (60Hz ONLY)	30
115/230 VOLT CONVERTIBLE MODEL	30
230 VOLT CONVERTED BEAM	30

SERVICE INFORMATION

GENERAL INFORMATION	32
GFCI AND HIGH LIMIT THERMOSTAT	32
NO-FAULT [®] HEATER AND INTEGRATED PRESSURE SWITCH	32
SILENT FLO 5000 [®] CIRCULATION PUMP AND CIRCULATION PUMP THERMAL CUT-OFF	32
MISCELLANEOUS SERVICE INFORMATION	32
ACTS INVALIDATING WARRANTY	33
DISCLAIMERS	33
WATKINS WELLNESS CUSTOMER SERVICE	33
TROUBLESHOOTING	33
SPA SPECIFICATIONS	36

SAFETY INFORMATION

IMPORTANT SAFETY INSTRUCTIONS

(READ AND FOLLOW ALL INSTRUCTIONS)

AVOIDING THE RISK TO CHILDREN

DANGER - RISK OF CHILD DROWNING

Extreme caution must be exercised to prevent unauthorized access by children. To avoid accidents, ensure that children cannot use a spa unless they are supervised at all times.

WARNING

To reduce the risk of injury, do not permit children to use this spa unless they are closely supervised at all times.

- To reduce the risk of injury, lower water temperatures are recommended for young children. Children are especially sensitive to hot water.
- Extreme caution must be exercised to prevent unauthorized access by children. To avoid accidents, ensure that children cannot use a spa unless they are supervised at all times.

DO:

- Make sure you always lock the child resistant locks after using the spa for your children's safety. Every **HOT SPRING** spa is equipped with a locking cover that meets the ASTM F1346-91 Standard for Safety Covers.
- Test the water temperature with your hand before allowing children to enter the spa to be sure that it's comfortable. Children are especially sensitive to hot water.
- Remind children that wet surfaces can be very slippery. Make sure that children are careful when entering or exiting the spa.

DON'T:

- Allow children to climb onto the spa cover.
- Allow children to have unsupervised access to the spa.

AVOIDING THE RISK OF ELECTROCUTION

DANGER - RISK OF ELECTROCUTION

- Connect only to a grounded source.
- Do not bury the power cord. A buried power cord may result in death, or serious personal injury due to electrocution if direct burial-type cable is not used, or if improper digging occurs.
- A ground terminal (pressure wire connector) is provided on the control box inside the unit to permit connection of a minimum No. 8 AWG (8.4 mm²) solid copper bonding conductor between this point and any metal equipment, metal water pipe, metal enclosures of electrical equipment, or conduit within five feet (1.5 m) of the unit as needed to comply with local requirements.

- Do not operate the audio main controls while inside the spa (if spa is equipped with an audio component).
- Do not connect any auxiliary components (for example, cable additional speakers, headphones, additional audio components) to the audio system unless approved by **WATKINS WELLNESS**.
- Do not self service audio component by opening spa door as this may expose dangerous voltage or other risk of injury. Refer all servicing to qualified service personnel.
- Do not attach an external antennae to a spa audio system unless installed by a licensed electrician in accordance with Article 810 of the National Electric Code, ANSI/NFPA 70.

WARNING

- To reduce the risk of electrical shock, replace a damaged cord immediately. Failure to do so may result in death or serious personal injury due to electrocution.
- Your spa is provided with a Ground Fault Circuit Interrupter (GFCI) for user and equipment protection. To ensure proper operation of this important safety device, test according to the following instructions per electrical configuration.
- **Cord-Connected 115 volt, 20 amp models:** The GFCI is located at the end of the power cord. Before each use, with the unit operating, push the TEST button. The unit should stop operating and the GFCI power indicator will go out. Wait 30 seconds and then reset the GFCI by pushing the RESET button. The GFCI power indicator will turn on, restoring power to the spa. If the interrupter does not perform in this manner, there may be an electrical malfunction and with it, the possibility of an electric shock. Disconnect the power until the problem has been corrected.
- **230 volt, permanently installed or converted models:**
 - A ground terminal is provided on the terminal block (TB-1, system ground terminal) located inside the control box. To reduce the risk of electric shock, connect this terminal to the grounding terminal of your electrical service or supply panel with a continuous green, insulated copper wire. The wire must be equivalent in size to the circuit conductors supplying the equipment. In addition, a bonding terminal (pressure wire connector) is provided on the outside of the control box for bonding to local ground points. To reduce the risk of electric shock, this connector should be bonded with a No. 8 AWG (8.4 mm²) solid copper wire to any metal ladders, water pipes, or other metal within 5 feet (1.5 m) of the spa to comply with local requirements. The means of disconnection must be readily accessible, but must be installed at least 5 feet (1.5 m) from the spa.
 - Your spa is provided with a suitably rated circuit breaker to open all ungrounded supply conductors.
 - Your spa uses ground fault circuit interrupters in the electrical subpanel. Before each use of the spa and with the unit operating, push the TEST button on each breaker. The switch should click over to the "Trip" position. Wait 30 seconds and reset each GFCI breaker by switching it completely off and then completely on. The switch should then stay on. If either of the interrupters does not perform in this manner, it is an indication of an electrical malfunction and the possibility of an electric shock. Disconnect the power until the fault has been identified and corrected.

IMPORTANT: Failure to wait 30 seconds before resetting the GFCI may cause the spa's Power Indicator (on the control panel) to blink. If this occurs, repeat the GFCI test procedure.

DANGER - RISK OF ELECTRICAL SHOCK

- Install at least 5 feet (1.5 m) from all metal surfaces. A spa may be installed within 5 feet of a metal surface if each metal surface is permanently connected by a minimum No. 8 AWG (8.4 mm²) solid copper conductor attached to the wire ground connector on the terminal box that is provided for this purpose if in accordance with National Electrical Code ANSI/NMFA70-1993.
- Do not permit any electrical appliances, such as a light, telephone, radio, or television within 5 feet (1.5 m) of a spa. Failure to maintain a safe distance may result in death, or serious personal injury due to electrocution, if the appliance should fall into the spa.
- Install your spa in such a way that drainage is away from the electrical compartment and from all electrical components.

DO:

- Be sure your spa is connected to the power supply correctly - use a licensed electrical contractor.
- Disconnect the spa from the power supply before draining the spa or servicing the electrical components.
- Test the Ground Fault Circuit Interrupter(s) before each use.
- Replace audio components only with identical components (if your spa is equipped with an audio component).

DON'T:

- Use the spa with the equipment compartment door removed.
- Place electrical appliances within 5 feet (1.5m) of the spa.
- Use an extension cord to connect the spa to its power source. The cord may not be properly grounded and the connection is a shock hazard. An extension cord may cause a voltage drop, which will cause overheating of the jet pump motor and motor damage.
- Attempt to open the electrical control box. There are no user serviceable parts inside.

RISKS TO AVOID

DANGER - RISK OF INJURY

- To reduce the risk of injury to persons, DO NOT remove suction fittings (filter standpipes) located in the filter compartment.
- The suction fittings in the spa are sized to match the specific water flow created by the pump. Never replace a suction fitting with one rated less than the flow rate marked on the original suction fitting.
- There is a danger of slipping and falling. Remember that wet surfaces can be very slippery. Take care when entering or exiting the spa.
- Never operate spa if the suction fittings are broken or missing.
- People with infectious diseases should not use the spa.
- Keep any loose articles of clothing, long hair, or hanging jewelry away from rotating jets or other moving components.

INCREASED SIDE EFFECTS OF MEDICATION

- The use of drugs, alcohol may cause unconsciousness with the possibility of drowning.
- Persons using medications should consult a physician before using a spa; some medication may cause a user to become drowsy, while other medication may affect heart rate, blood pressure, and circulation.

- Persons taking medications which induce drowsiness, such as tranquilizers, antihistamines, or anticoagulants should not use the spa.

HEALTH PROBLEMS AFFECTED BY SPA USE

- Pregnant women should consult a physician before using spa.
- Persons suffering from obesity, or with a medical history of heart disease, low or high blood pressure, circulatory system problems, or diabetes should consult a physician before using spa.

UNCLEAN WATER

- Keep the water clean and sanitized with correct chemical care. The recommended levels for your **HOT SPRING** spa are:

Free Available Chlorine: 1.0-5.0ppm	Total Alkalinity: 40-120ppm
Water pH: 7.2-7.8	Calcium Hardness: Standard 75-150ppm Salt System 25-75ppm

- Refer to Water Quality and Maintenance section for complete instructions.

IMPORTANT: Turn on the jet pump for a least ten minutes after adding ANY spa water chemicals into the filter compartment.

Clean the filter cartridges monthly to remove debris and mineral buildup which may affect the performance of the hydromassage jets, limit the flow, or trip the high limit thermostat, which will turn off the entire spa.

AVOIDING THE RISK OF HYPERTHERMIA

Prolonged immersion in hot water can result in HYPERTHERMIA, a dangerous condition which occurs when the internal temperature of the body reaches a level above normal 98.6°F (37°C). The symptoms of hyperthermia include unawareness of impending hazard, failure to perceive heat, failure to recognize the need to exit the spa, physical inability to exit the spa, fetal damage in pregnant women, and unconsciousness resulting in a danger of drowning.

WARNING

The use of alcohol, drugs, or medication can greatly increase the risk of fatal hyperthermia in hot tubs and spas.

TO REDUCE THE RISK OF INJURY

- The water in the spa should never exceed 104°F (40°C). Water temperatures between 100°F and 104°F (38°C and 40°C) are considered safe for a healthy adult. Lower water temperatures are recommended for extended use (exceeding ten minutes) and for young children. Extended use can cause hyperthermia.
- Pregnant or possibly pregnant women should limit spa water temperatures to 100°F (38°C). Failure to do so may result in permanent injury to your baby.
- Do not use spa immediately following strenuous exercise.

AVOIDING THE RISK OF SKIN BURNS

- To reduce the risk of injury, before entering a spa the user should measure the water temperature with an accurate thermometer.
- Test the water with your hand before entering the spa to be sure it's comfortable.

SAFETY SIGN

Each **HOT SPRING** spa is shipped with a SAFETY SIGN in the owner's package. The sign, which is required as a condition of Product Listing, should be permanently installed where it is visible to the users of the spa. To obtain additional SAFETY SIGNS, contact your **HOT SPRING** dealer and request Part #70798.

IMPORTANT SPA INSTRUCTIONS

The following contains important spa information, and we strongly encourage you to read and apply them.

DO:

- Use and lock the vinyl cover when the spa is not in use, whether it is empty or full.
- Follow the Spa Care and Maintenance recommendations stated in this manual.
- Use only approved accessories and recommended spa chemicals and cleaners.

DON'T

- Leave the **HOT SPRING** spa exposed to the sun without water or the cover in place. Exposure to direct sunlight can cause solar distress of the shell material.
- Roll or slide the spa on its side. This will damage the siding.
- Lift or drag the vinyl cover by using the cover lock straps; always lift or carry the cover by using the handles.
- Attempt to open the electrical control box. There are no user serviceable parts inside. Opening of the control box by the spa owner will void the warranty. If you have an operational problem, carefully go through the steps outlined in the Troubleshooting section. If you are not able to resolve the problem, contact your authorized **HOT SPRING** dealer. Many problems can easily be diagnosed over the telephone by an Authorized Service Technician.

SPA SHELL

Your **HOT SPRING** spa has an acrylic shell. Stains and dirt generally will not adhere to your spa's surface. A soft rag should easily remove most dirt. Most household chemicals are harmful to your spa's shell (see below for detailed information on cleaning agents). Always rinse off any spa shell cleaning agent with fresh water.

IMPORTANT:

1. The following products are the **ONLY** approved cleaning agents for your **HOT SPRING** spa shell: plain water, **HOT SPRING FRESHWATER Spa Shine**, or **Soft Scrub®**. The use of alcohol or any other household cleaner other than those listed to clean the spa shell surface is **NOT** recommended. **DO NOT** use any cleaning products containing abrasives or solvents since they may damage the shell surface, specifically: **Simple Green®**, **Windex®** or **Spa Mitt**. **NEVER USE HARSH CHEMICALS!** Damage to the shell by use of harsh chemicals is not covered under the warranty. Always rinse off any spa shell cleaning agent with fresh water.
2. Iron and copper in the water can stain the spa shell if allowed to go unchecked. Ask your **HOT SPRING** dealer about a Stain and Scale Inhibitor to use if your spa has a high concentration of dissolved minerals. (**WATKINS WELLNESS** recommends **FRESHWATER Stain & Scale Defense**.)
3. Keep all cleaners out of the reach of children and use care when applying.

SAVE THESE INSTRUCTIONS

GETTING STARTED

SPA FEATURES



1) **Standard LCD Control Panel.** The control panel is accessible from inside or outside the spa and is designed for ease of use.



2) The **Diverter** lets you divert water to different combinations of jets simply by turning the lever.



3) The **Air Control** lever lets you dial in the ideal amount of air for the Precision® Jets.



4) The **Water Feature** lever adjusts the amount of water that flows from the water features.



5) The **XL Directional** jet with directional nozzle provides maximum performance



6) The **XL Single Rotary** jet provides greater flow through one rotatory opening creating a unique massage pattern.



7) The **XL Dual Rotary** jet provides greater flow through two balanced rotary openings creating a pulsating massage pattern.



8) The **Standard Directional** with a directional nozzle provides a strong flow of water.



9) The **Standard Single Rotary** jet with one rotary opening provides a strong unique massage.



10) The **Standard Dual Rotary** jet with two balanced rotary openings provide a strong pulsating massage.



11) The Directional **PRECISION** jet delivers a therapeutic massage.



12) The Rotary **PRECISION** jet delivers a therapeutic massage.



13) **FRESHWATER** salt system housing cap.



14) The **Raio® multi-color points of light** system, provides lighting on the interior of the spa.



15) The **Vidro®** water feature adds tranquility to your spa experience.



16) **Pillow** - All spas come with one or more pillows.



17) **Spa Filters** provide water filtration for the spa (under filter lid).



18) This is the **suction fitting/spa drain**.



19) 1.5 inch Speaker (optional).

PRECISION JETS

Precision jets are small, producing a precisely narrow stream of massaging action. They are placed in groups to perform a soft, soothing massage.

DIRECTIONAL AND ROTARY JETS

These jets deliver a great massage to the feet, back and shoulder areas. These jets may provide either a direct stream, or two different types of rotating massage patterns. Also, the speed of the rotation can be changed by rotating the jet faceplate from a full stream, to shutting the jet completely off. To avoid damage to your spa's plumbing and components, do not turn off more than half of these jets at the same time.

WATER FEATURE

The **PRISM**, **PULSE**, **FLAIR**, and **FLASH** spas come equipped with a Vidro® water feature. This water feature can be turned on or off when the two-speed pump is on low speed (tranquil mode) or high speed. To function correctly, the water feature on/off lever must be placed in the full on position only.

If the lever is not in the full on position when the pump is on high speed, it is likely that the water feature will project water substantially farther into the spa as the on/off lever is opened. This is not proper operation. If this occurs, the pump should be turned off, the water feature lever rotated to the full on position and the pump turned on again.

When not in use turn the on/off lever to the OFF position.

CAUTION: Partial blockage of water flow at entrance of water feature will cause the water to flow farther into or over the spa.

HOT SPRING LOGO LIGHT

The **HOT SPRING** logo on the front of the spa illuminates several colors. These colors indicate the power, water temp ready and status of the spa without having to open the cover to look at the control panel.

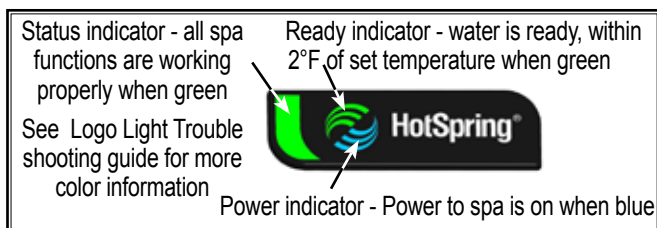

Ready Indicator: The GREEN indicator will light when the spa water temperature is within 2°F (1°C) of the set temperature, and will turn off when the temperature is outside of that range. If you increase or decrease the temperature setting of the spa, the ready indicator will turn off until the water temperature reaches the acceptable range for the new temperature setting. A flashing RED indicator means a problem may exist with the temperature sensor (see Logo Light Troubleshooting section for more information).

Power Indicator: The BLUE indicator is 'on' when the spa is properly supplied with power. It also provides a diagnostic function—a flashing RED indicator indicates that the heater high limit has tripped, meaning that either the spa water is above its acceptable temperature range, or a malfunction has occurred within the spa (such as low circulation due to clogged filters). An 'off' BLUE indicator means that there is a problem with the spa control box or the power supplied to the spa (see Logo Light Troubleshooting section for more information).

Status Indicator: A GREEN indicator is on when spa functions are working normally. A YELLOW indicator is on when a spa function requires attention. A RED indicator is on and flashing when there is an issue with the spa functions and needs immediate attention (see Logo Light Troubleshooting section for more information).

QUICK START-UP INSTRUCTIONS

BEFORE YOU FILL YOUR SPA

Make sure your spa has been properly installed per all local codes, this includes the location of the spa, the foundation of the spa as well as the electrical installation of the spa. Installation instructions in the form of a Pre-Delivery Instruction booklet can be obtained from either your **HOT SPRING** dealer or online at: www.HotSpring.com/planning-tools/pre-delivery-instructions

DO:

- Know which water treatment system you will be using and make sure you have necessary chemicals available. Read all of the instructions that come with the system.
- Have **FRESHWATER** 5-way Test Strips Available.
- Have **FRESHWATER** Salt Test Strips Available if using the Salt system.
- Have pH/Alkalinity Up & Down available.
- Know the "Hardness" of your water, contact your dealer to help you with this information. See Water Quality and Maintenance for more information. **IMPORTANT:** The spa can be filled with "softened" water as long as the calcium hardness parameters (pg. 2) are maintained.
- Purchase the Clean Screen® pre-filter to remove unwanted contaminants from the tap water. This is recommended, not required.

DON'T:

- Power up the spa until it has been filled with water! Power to the spa automatically activates critical components within the spa, such as controls, heater, circulation pump, and other systems. If power is supplied to these components prior to the spa being filled, the components will be damaged, and this may result in a non-warranty component failure.
- Fill the spa with hot water or cold water with cold water temperature below 50° F (10° C)! Tripping of the high-limit thermostat may result causing your spa to stop functioning.
- Use your spa after filling until all of the steps listed below START-UP are completed!
- Add chlorine if treating your spa with polyhexamethylene biguanide (Biguanide, PHMB, eg. BaquaSpa®) sanitizer.

START-UP

Your **HOT SPRING** spa has been thoroughly tested during the manufacturing process to ensure reliability and long-term customer satisfaction. A small amount of water may have remained in the plumbing after testing and, as a result, may have spotted the spa shell or the spa siding prior to delivery. Before filling the spa, wipe the spa shell clean with a soft rag.

The following instructions must be read and followed exactly to ensure a successful start-up or refill.

- 1. CLOSE DRAIN AND FILL THE SPA** with water through the filter compartment. Your **HOT SPRING** spa water level should be maintained just below the bottom of the pillow.
- 2. AFTER THE SPA HAS BEEN FILLED** with water and the equipment compartment door is secured, power must be applied to the spa.
 - **115 volt models:** Connect the GFCI to the waterproof receptacle and push the RESET button on the GFCI.
 - **230 volt models:** Open the door of the electrical subpanel, reset the 30 amp GFCI breaker first, verify the system is primed, then reset the 20 amp breaker. Close and secure the subpanel door.
- 3. TO CHECK THE OPERATION OF THE JET SYSTEM** and to purge any remaining air from the heating system:
PULSE, FLAIR & FLASH Models:
 - Push the JETS hard button.
 - Push the JET MAX soft button to run pumps on high speed, run for one minute. Press JETS OFF soft button to shut all the jets off.**BEAM Model:**
 - Push the JETS Hard button to run the jet pump on high speed, run for one minute. Press JETS OFF soft button to shut the JETS off.**PRISM Model:**
 - Push the JETS hard button.
 - Push the JETS MAX soft button to turn on all the jets and run for one minute. Press the soft button next to each Jet # to shut off the jets.

Weak or surging jets are an indication of a low water level condition or clogged filter cartridges.

IMPORTANT: Be sure the air Lever (see illustration in Spa Features section) is open by turning clockwise until it stops. Combination jet faces can be turned to completely shut off jet flow, these jets should be open as well.
- 4. USING A TEST STRIP AND APPLICABLE CHEMICALS,** adjust Total Alkalinity (TA) to 80 ppm, Calcium Hardness (CH) between **75-150ppm** (if using **Salt System 25-75ppm**), then spa water pH to between 7.4 and 7.8. These procedures are listed in the "Water Quality and Maintenance" section.

IMPORTANT: Always add spa water chemicals directly into the filter compartment with the jet pump on high speed for at least ten minutes. Adjusting the Total Alkalinity (TA) as the first step is important, as out-of-balance TA will affect your ability to adjust the pH correctly and will prevent the sanitizer from operating effectively.
- 5. SUPERCHLORINATE THE SPA WATER** by adding 1½ teaspoons of chlorine (sodium dichlor) per 250 gallons (950 liters) of spa water with the spa in the Cleaning mode.
All **HOT SPRING** spas are equipped with a Cleaning mode. When the mode is activated, the jet pump in the first jet system will turn on and run for ten minutes (used for water maintenance). To activate

the Cleaning mode, press the CLEAN soft button (on home screen) to turn on the jet pump.

DURING THE SUPER-CHLORINATION PERIOD, rotate the **DIVERTER** lever(s) through both operating positions, letting the spa water circulate (with jets on) for equal periods of time. The **HOT SPRING** spa's diverter levers are designed to operate different jets in two different positions.

- 6. SET THE TEMPERATURE CONTROL,** the spa is pre-programmed to reach 100°F (38° C), and will normally do so within 18 to 24 hours. You may raise or lower the water temperature by:
 - Pressing the OPTIONS hard button on the control panel.
 - Pressing the soft button next to **Temperature**.
 - Pressing the soft button next to TEMP ▲ button on the control panel to raise the temperature.
 - Pressing the soft button next to TEMP ▼ button on the control panel to lower the temperature.

Place the vinyl cover on the spa and allow the water temperature to stabilize. Make sure you secure the cover in place using the cover locks. Periodically check the spa water temperature. When the water temperature climbs above 90°F (32°C), proceed to the next step.

To prevent tampering, you can lock your desired temperature setting. Refer to the Operating section for details.
- 7. ACTIVATE THE CLEAN CYCLE** as described in step 5 to turn on the CLEAN cycle to circulate the spa water. After the clean cycle is complete, test the spa water for Free Available Chlorine (FAC) residual. If the residual is between 3 and 5ppm on the test strips (found in the test kit) go on to the next step. If the residual is less than 3ppm, superchlorinate the spa water by adding 1½ teaspoons of chlorine (sodium dichlor) per 250 gallons (950 liters) of spa water. Activate the clean cycle again to circulate the spa water for another ten-minute period.
- 8. ROTATE THE DIVERTER LEVER(S) TO OPPOSITE POSITION.** Activate the clean cycle as described in step 5. Test the spa water for Free Available Chlorine (FAC) residual. If the residual is between 3 and 5ppm on the test strips (between 1 - 5ppm if using the Salt system) go on to the next step. If the residual is less than 3 ppm, superchlorinate the spa water by adding 1½ teaspoons of chlorine (sodium dichlor) per 250 gallons (950 liters) of spa water. Then Activate the clean cycle again to circulate the spa water for another ten-minute period. Repeat this procedure until both diverter lever(s) operating positions have been tested.
- 9. RECHECK** the Total Alkalinity (TA) at 80ppm, Calcium Hardness (CH) between **75-150ppm** (if using Salt system between **25-75ppm**), then spa water pH at between 7.2 and 7.8. using a **FRESHWATER** 5-way test strip.

IMPORTANT: Make sure you adjust your Total Alkalinity first, as an out-of-balance condition will affect your ability to adjust the pH correctly, and will prevent the sanitizer from operating effectively. **The spa is ready for use when the spa water has circulated through each diverter lever operating position and the chlorine level remains between 3ppm and 5ppm.**
- 10. TEST WATER WEEKLY OR BEFORE EACH TIME THE SPA IS USED**

GETTING STARTED

EQUIPMENT COMPARTMENT

The illustration below is to be used as a reference only (your spa may look different). The equipment compartment is located behind the front panel of the spa below the control panel.

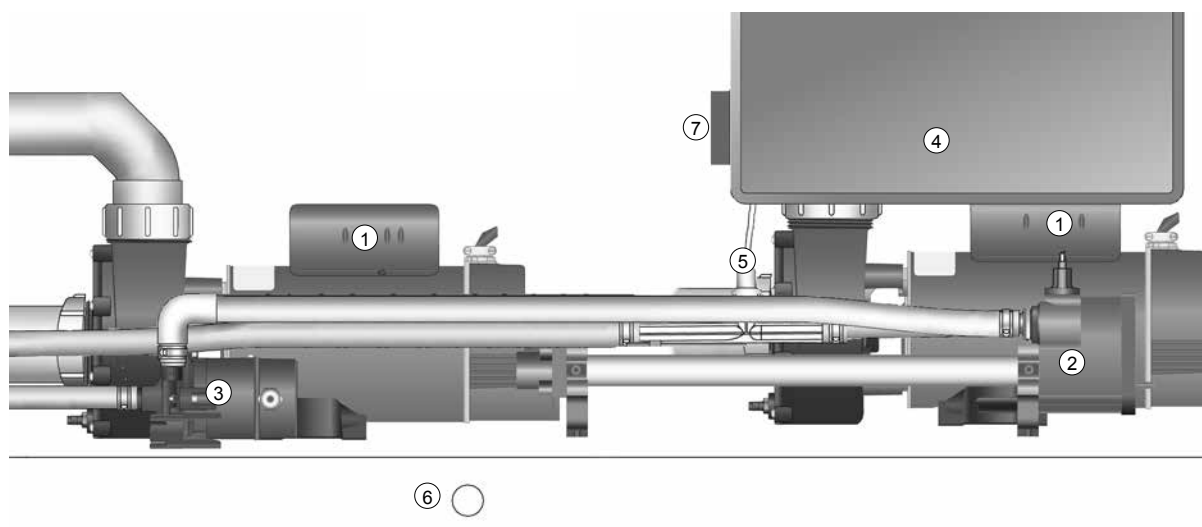

EQUIPMENT COMPARTMENT

- | | |
|--------------------------------------|------------------------------|
| 1. Wavemaster® jet pump | 5. Ozone injector (optional) |
| 2. No-Fault® heater | 6. Drain |
| 3. Silent Flo 5000® circulation pump | 8. Bonding terminal |
| 4. IQ 2020® control box | |

WATER QUALITY AND MAINTENANCE

BASIC INFORMATION

It's important to have clean water. Water maintenance is one of the least understood, yet most important, areas of spa ownership. Your dealer can guide you through the process of achieving and maintaining perfect water in your spa, given your local conditions.

IMPORTANT: Water Terminology can be found at the end of this section.

- **Always read & refer to the owner's manual** for complete information.
- **Test your water** with a test strip once a week, or each time the spa is used.
- **Add chemicals** in frequent small amounts to prevent overdosing the spa.
- **Use the spa only** when the chlorine level is between 1-5 ppm manually add chlorine as needed.
- **When using a Salt System**, read & refer to separate owner's manual.
- **It is the spa owner's responsibility** to prevent over or under chlorination.
- **Drain & refill water** 3-4 times per year depending on how often you use your spa, and how many people use it (unless using the Salt System).

IMPORTANT: Remember to change your water every three to four months. Spa water that is maintained using a Salt Sanitizing System may last much longer - up to twelve months, with proper care*. Refer to the Salt Sanitizing system owner's manual for detailed instructions.

Check with your **HOT SPRING** dealer to determine if water in your region has unique qualities - such as high metal or mineral content - that should be addressed.

Your program will depend on your water's mineral content, how often you use your spa, and how many people use it.

WATER QUALITY CHART

PARAMETER	TARGET	MIN - "OK" RANGE - MAX	
pH	7.4	7.2	7.8
ALKALINITY	80 ppm	40 ppm	120 ppm
CALCIUM HARDNESS	100 ppm	75 ppm	150 ppm
CALCIUM HARDNESS (SALT SYSTEM)	50 ppm	25 ppm	75 ppm
CHLORINE	3 ppm	1 ppm	5 ppm

Maintaining the water quality and the cleanliness of the filters in your spa is your responsibility. Keeping the spa water balanced prolongs the life of the spa components and will make the water more comfortable. Your dealer can guide you through the process of achieving and maintaining perfect water in your spa, given your local conditions. Your program will depend on your water's mineral content, how often you use your spa, and how many people use it. **WATKINS WELLNESS** has developed several water care systems and products to simplify water care which are available from authorized **HOT SPRING** dealers.

FRESHWATER Salt System	Vanishing Act® Calcium Remover
FRESHWATER Salt Test Strips	CLEAN SCREEN Prefilter
FRESHWATER 5-way Test Strips	

*For more information visit www.hotspring.com/save-water

CHEMICAL SAFETY

When using chemicals, read the labels carefully and follow directions precisely. Though chemicals protect you and your spa when used correctly, they can be hazardous in concentrated form. Always observe the following guidelines:

- Allow only a responsible person to handle spa chemicals. Keep them out of the reach of children.
- Accurately measure the exact quantities specified, never more. Do not overdose your spa.
- Handle all containers with care. Store in a cool, dry, well ventilated place.
- Always keep chemical containers closed when not in use. Replace caps on their proper containers.
- Don't inhale fumes, or allow chemicals to come in contact with your eyes, nose, or mouth. Wash your hands immediately after use.
- Follow the emergency advice on the product label in case of accidental contact, or if the chemical is swallowed. Call a doctor or the local Poison Control Center. If a doctor is needed, take the product container along with you so that the substance can be identified.
- Don't let chemicals get on surrounding surfaces or landscaping. Don't use a vacuum cleaner to clean up chemical spills.
- Never smoke around chemicals. Some fumes can be highly flammable.
- Don't store any chemicals in the spa equipment compartment.

HOW TO ADD CHEMICALS TO THE WATER

IMPORTANT: All spa water chemicals, including granulated dichlor, MPS, granulated pH increaser or decreaser, granulated total alkalinity increaser, liquid stain and scale inhibitor, and liquid defoamer must always be added directly into the filter compartment while the jet pump is running in its high speed mode, and it must run for a minimum of ten minutes.

To Administer Spa Water Chemicals:

1. Fold back the cover. Carefully remove and set aside the filter compartment cover.
2. On your Control Panel:
 - Push the CLEAN soft button (on home screen) to turn on the jet pump.
3. Carefully measure the recommended amount of chemical and slowly pour it into the filter compartment. Use care not to splash chemicals on your hands, in your eyes, on the spa shell surface, or on the spa cabinet.
4. Replace the filter compartment cover. After ten minutes, the jet pump will automatically shut off to complete the procedure. Close and secure the cover.

⚠ DANGER: Risk of Drowning: Never leave an open spa unattended!

IMPORTANT: After administering a super chlorination treatment or non-chlorine shock to your spa, leave the cover open for a minimum of 20 minutes to allow the oxidizer gas to vent. A high concentration of trapped oxidizer gas which may exist as a result of the shock treatment (not daily sanitation) may eventually cause discoloration or vinyl degradation to the bottom of the cover. This type of damage is considered chemical abuse and is not covered under the terms of the limited warranty.

FUNDAMENTALS OF WATER MAINTENANCE

- **Testing:** Test the water weekly or each time the spa is used with convenient **FRESHWATER** 5-way Test Strips or more accurate liquid/tablet reagent test kit per instructions. Critical parameters: sanitizer level, pH, Calcium Hardness (CH), and Total Alkalinity (TA). Store test equipment in a dark, cool, dry place to maintain potency.
- **Water Filtration:** The filtration used in **HOT SPRING** spas helps keep water clean by circulating sanitizer and removing waste from the spa. Regularly inspect and clean filters for peak performance
- **Chemical Balance/pH Control:** It is important to adjust the primary water parameters (Total Alkalinity, Calcium hardness, pH) into the recommended ranges so that they are stabilized or balanced. Balance the water chemistry every time you fill the spa with new water and then during the life of that body of water. Keeping the water in balance prevents damage by holding the pH in a safe range and preventing calcium scale formation on spa equipment. A low pH can damage metal components whereas a high pH can cause high levels of calcium to form scale. Your dealer should provide a detailed water chemistry orientation soon after your new spa is filled for the very first time.

ALKALINE SPA WATER (SCALING ZONE)	8.2	ADD pH DECREASER TO LOWER pH
	7.8	
COMFORT ZONE	7.6	IDEAL
	7.4	
	7.2	
ACIDIC SPA WATER (CORROSIVE ZONE)	6.8	ADD pH INCREASER TO RAISE pH
	pH	

- The following three water components must be kept in balance to avoid damage to the spa. Do balance these components in the order they are listed here as each will help you balance the next using a minimum amount of chemicals.
1. Calcium Hardness (CH) – CH is the measure of the amount of dissolved calcium in the water. Low levels can make the water corrosive and high levels cause scale formation of spa components. The recommended CH reading is between **75 - 150 ppm**. A hardness between **25 - 75 ppm** is recommended with a Salt System. If the CH level is too high, lower it with the **VANISHING ACT** calcium remover per instructions. Once in balance, the CH reading normally remains stable until new water is added. Great care must be taken when filling the spa from a water softener to ensure that the calcium remains in balance and avoid damage to the spa.
 2. Total Alkalinity (TA) - TA is a measure of the water's ability to resist changes of pH or buffer capacity. A low TA allows the pH to fluctuate easily. The recommended TA reading is between **40 - 120 ppm**. To raise the TA, use **FRESHWATER** pH/Alkalinity Up (sodium hydrogen carbonate). To lower the TA, use **FRESHWATER** pH/Alkalinity Down (sodium bisulfate). Once the TA is balanced, it normally remains stable until the next drain/refill. We recommend you check the TA reading once per month. Raising/lowering the TA may cause the pH readings to fluctuate widely. Ignore the pH readings on the test strip while you are balancing the TA.
 3. pH - The pH is the measure of the acidity and alkalinity. Maintaining the proper pH level will optimize the effectiveness of the sanitizer, preventing damage to the spa and physical discomfort for spa users. A low pH dissipates sanitizer, causes corrosion, and irritates spa users. A high pH level will neutralize sanitizer, promote scaling and cloud water. The recommended pH reading is between **7.2 - 7.8**. To

lower the pH level, use **FRESHWATER** pH/Alkalinity Down (sodium bisulfate). To raise the pH level, use **FRESHWATER** pH/Alkalinity Up (sodium carbonate).

- **Water Conditioners:** Spa fill water varies from location to location and user to user, therefore it is important to consult with your dealer for an appropriate program.
 - a. **VANISHING ACT** – High levels of calcium and some minerals can be removed from the water with the single use **VANISHING ACT**. High calcium levels can cause scale formation on the spa equipment and shell.
 - b. **CLEAN SCREEN** pre-filter –The **CLEAN SCREEN** pre-filter should be used at every fill and top-off to remove contaminants from the fill water, especially iron, copper, and manganese. Many water sources including well water contain high concentrations of minerals that can cause staining of the shell and plastics.
 - c. Stain and Scale control – For water high in calcium and minerals, it may be necessary to use an anti-scalant like Stain and Scale control. As water evaporates from your spa and new water is added, the amount of dissolved minerals like calcium, copper, iron, and manganese will increase. (Minimize evaporation by keeping the cover on the spa whenever possible.) High iron or copper content in the water may produce green or brown stains on the spa.
 - d. Foam Inhibitors - Soap is introduced into the spa water from users' bodies and swimming apparel and can cause the spa water to foam when the jets are used. Low levels of calcium hardness (soft water) can increase foaming. Although ozone and Salt Systems can oxidize soap residual, it may become necessary to add Foam Inhibitors to suppress the foam. Excessive soap in the water may require a water change to resolve.
- **Oxidizers:** Ozone and Monopersulfate (MPS) are oxidizers used to prevent the buildup of contaminants, maximize sanitizer efficiency, minimize combined chlorine, and improve water clarity. They are to be used in conjunction with EPA registered sanitizers. The **FRESHWATER** III high output ozone system uses Corona Discharge technology to produce a high concentration of ozone which is injected into the spa water 24 hours per day. **FRESHWATER** Chlorine-Free Oxidizer, Monopersulfate (MPS) is a granular oxidizing chemical.
- **Sanitizers:** Maintaining the recommended residual level of an EPA registered sanitizer at all times will decrease the occurrence of unsafe bacteria and viruses in your spa water. The recommended Free Available Chlorine (FAC), the amount of available chlorine sanitizer, is **3.0-5.0 ppm**. A low FAC can allow bacteria and viruses to grow rapidly in the warm water, and a high FAC can cause discomfort to the user's eyes, lungs, and skin. Each sanitizer carries its own instructions regarding how much to use and when to add it to the spa water. Consult your dealer for their recommendations and instructions on proper sanitizing of the spa.
 - a. **FRESHWATER** Salt System
 - b. **FRESHWATER** Concentrated Chlorinating Granules
 - c. Sodium Dichloro-s-Triazinetrione (sodium dichlor or chlorine)
 - d. Liquid chlorine (sodium hypochlorite)
 - e. Brominating Concentrate (one step granular bromine).
 - f. BaquaSpa® (please consult your **BAQUASPA** manual for instructions on the use of this product).

IMPORTANT: DO NOT use tri-chlor chlorine, bromo-chloro-dimethyl-hydantoin (BCDMH), or any type of compressed bromine or chlorine, acid or any type of sanitizer which is not recommended by **WATKINS WELLNESS**.

THE HOT SPRING SPA WATER MAINTENANCE PROGRAM

FILLING THE SPA WITH WATER

Use the **CLEAN SCREEN** Pre-filter to remove unwanted contaminants such as rust, dirt, detergents, and algae from the fill water. Dissolved metals, copper, iron, and manganese are also removed. Instructions are included with the **CLEAN SCREEN** Pre-filter. Always fill the spa through the filter compartment. Do not fill your spa using water from a swimming pool as pool chemicals are very different from those used in a spa and can damage your spa.

ADDING CHEMICALS TO THE WATER

All spa water chemicals, including granulated dichlor, MPS, granulated pH increaser or decreaser, granulated total alkalinity increaser, liquid stain and scale inhibitor, and liquid defoamer must always be added directly into the filter compartment while the jet pump is running in its high speed mode, and it must run for a minimum of ten minutes with the cover off. Use the Clean button/feature to ensure that the chemicals are properly mixed when adding.

BUILDING A SANITIZER ROUTINE

During the first month of ownership, measure the sanitizer residual daily in order to establish a baseline of sanitizer needed vs. spa usage. Sanitizer needed is the amount of Free Available Chlorine needed to accommodate the number of users and their combined usage time. For example, two spa users for twenty minutes every day creates regular demand on the sanitizer that is used to determine how much sanitizer to add in order to maintain the proper residual. If the usage pattern increases dramatically with invited guests, the amount and frequency of sanitizer required increases dramatically.

PERFORMING SUPER CHLORINATION/ NON-CHLORINE SHOCK TREATMENT

A weekly or monthly super chlorination (1.5 tsp dichlor/250 gal) or shock (4tbsp mps/250 gal) may be required of your chosen sanitation program. Increasing chlorine to 5 ppm for 24-48 hours removes excess waste and chloramines from the water. Sodium dichlor is 6x stronger than MPS and may be a more appropriate for those users that experience heavy bather load conditions. Operate all jets and leave the cover open for a minimum of 20 minutes to allow the oxidizer gas to vent to prevent damage and discoloration to the cover and pillows after administering a super chlorination or shock to your spa. This type of damage is considered chemical abuse and is not covered under the terms of the limited warranty.

IMPORTANT: Always allow the Free Available Chlorine to fall below 5 ppm before using your spa.

 **DANGER:** Never leave an open spa unattended, especially if there are children present!

FRESHWATER SALT SYSTEM (OPTIONAL)

The Salt System converts water and sodium chloride salt into chlorine sanitizer. This is compatible with chlorine based systems and chemicals. Although the system is reduced maintenance, it is not automatic. It is important that the user regularly tests and balances the water. A calcium hardness between **25 - 75 ppm** is recommended to extend the life of the hardware. Consult the Salt system User Guide for additional instructions.

ADDITIONAL WATER CARE PRODUCTS

- **CLEAN SCREEN** Pre-filter
- **FRESHWATER** Concentrated Chlorinating Granules, Sodium Dichlor
- **FRESHWATER** Chlorine-Free Oxidizer, Monopersulfate (MPS)
- **FRESHWATER** III high output ozone system
- **FRESHWATER**_{Ag}+ Silver Ion purifier
- **VANISHING ACT** Calcium remover

The Silver Ion purifier introduces silver ions into the spa water via erosion of silver infused beads which inhibits bacteria growth. When combined with MPS, or chlorine, waste is oxidized and removed from the water.

It is important to follow the recommended application and maintenance programs outlined for each product's use. If the spa is being used over an extended period of time, such as a whole afternoon or evening, additional sanitizer will be needed.

Required: Weekly Super Chlorinate/Shock the spa to reactivate the silver ion cartridge, allow the release of silver ions, and quickly destroy any remaining contaminants. Without this weekly shock treatment, the silver ion cartridge may stop releasing silver ions into the water.

IMPORTANT: Use only Dichlor or liquid chlorine sanitizer. Silver is not compatible with bromine and biguanides. Don't use a water clarifier. Clarifiers will cause the spa water to become cloudy.

MANUAL CHLORINE (SODIUM DICHLOR)

WATKINS WELLNESS recommends the use of **FRESHWATER** Concentrated Chlorinating Granules (sodium dichlor) for sanitizing the water. Sodium dichlor is preferred because it is totally soluble, dissolves quickly, and is nearly pH neutral. The recommended Free Available Chlorine (FAC), the amount of available chlorine sanitize the spa, 3.0 - 5.0 ppm.

If the FAC is too low: Increase the FAC by adding granulated sodium dichlor.

If the FAC is too high: Allow time to pass and the FAC level will naturally drop over time.

If the spa smells of chlorine: super chlorinate or shock the spa FAC chlorine does not have an odor whereas combined spent chlorine (chloramines) has a strong chlorine odor that can be eliminated by shocking the water.

IMPORTANT: There are several forms of stabilized chlorine available for use in spas and swimming pools. It is extremely important to choose one specifically designed for spas. Use of an incorrect product such as tri-chlor which has a very low pH (2.6) and dissolves too quickly in hot water, results in extremely high levels of chlorine that **WILL** cause damage to your spa. Use of a compressed bromine/chlorine or unapproved sanitizer **WILL** damage your spa and is specifically not covered under the terms of the limited warranty.

VANISHING ACT INSTRUCTIONS

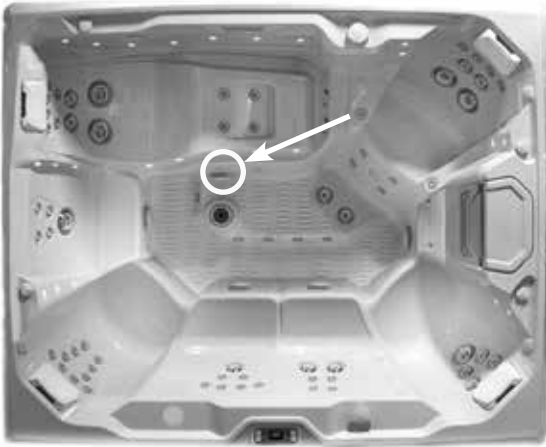

PRISM

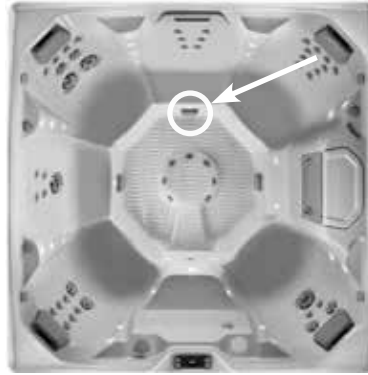

PULSE



FLAIR

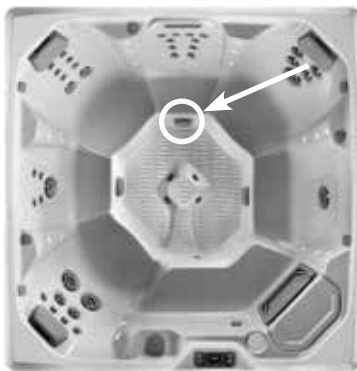

FLASH

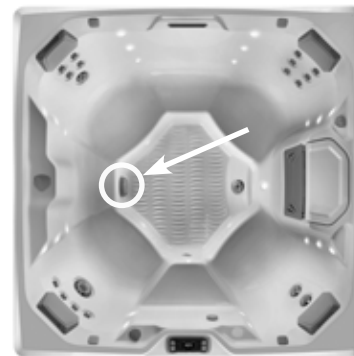

BEAM

Instructions for Use:

1. After Filling your hot tub, use a test strip to measure the hardness level of the water. If hardness is above **100 ppm**, use the **VANISHING ACT** calcium remover to soften the water. **Suggested Hardness Level: between 75 - 150 ppm, (it must be between 25 - 75 ppm when using the FRESHWATER Salt System in order to work).**
2. Rinse the **VANISHING ACT** calcium remover with running water until water runs clear. When placed in the hot tub, slight color transfer to the water may occur and can be easily resolved with chlorine.
3. Locate your spa above to determine which jet suction fitting the **VANISHING ACT** calcium remover will be placed up over. Use the circle to determine location.
 - a. Press **OPTIONS** hard button on the Control panel.,
 - Press the soft button next to **Set-Up**.
 - Press the soft button next to **More**.
 - Press the soft button next to **VANISHING ACT** to start low speed jet pump for 6 hours.
 - Place the **VANISHING ACT** calcium remover firmly against the associated jet suction fitting.
 - b. Test the spa water for hardness after jets shut off, which will take around 6 hours.

IMPORTANT:

- Always make sure water is balanced and properly sanitized, using the EPA approved sanitizer, before entering your hot tub.
- For maximum effectiveness, ensure that the calcium remover remains on the suction fitting while the calcium remover is in use.
- Calcium remover may not be necessary if water hardness is already in or below the suggested range.
- Multiple calcium removers maybe needed if initial water hardness is above 200 ppm.

OZONE MAINTENANCE (OPTIONAL)

Reduced or no ozone bubbles coming from heater return (clogged ozone injector) or no ozone, clean the injector:

1. Place 16 ounces of white vinegar into a cup or bucket.
2. Carefully loosen the long tubing attached to the bottom of the ozonator, located in the equipment compartment.
⚠ DANGER: Place the end of the tubing into the vinegar, making certain that the end of the tubing sits at the bottom of the container.
3. Run the spa until all 16 ounces of the vinegar are gone. This should allow an ample flow of vinegar to be run through the injector and clear the blockage.
4. Reinstall the tubing to the bottom of the ozonator.

Water chemistry damage is not covered by the warranty. The chemical levels and water quality in the spa are under your direct control. With proper basic care, the spa will provide many years of hot water relaxation. If you are unsure about any chemical or its usage in the spa, contact your Authorized Dealer, or **WATKINS WELLNESS**.

DO:

- Add all chemicals slowly into the filter compartment with the jet pump operating for ten minutes.
- Use granular (dichlor) or liquid (sodium hypochlorite) chlorine.
- Use special care if using baking soda to clean either the interior or exterior plastic surfaces.

IMPORTANT: WATKINS WELLNESS DOES NOT recommend the use of any floating chemical dispenser. Damage to the spa shell or components caused by a floating chemical dispenser is specifically not covered under the terms of the limited warranty. Floating dispensers can become trapped in one area and cause an over-sanitization or release large chunks of sanitizer that very quickly chemically burns the shell and cover.

DON'T:

- Use compressed sanitizers.
- Use a floater type sanitization system as a low or no maintenance solution to your spa maintenance program.
- Use a sanitizer which is not designed for spas.
- Use swimming pool (muriatic) acid to lower pH.
- Broadcast or sprinkle the chemicals onto the water surface. This method may cause chemically-induced spa surface blistering (chemical abuse).

VACATION WATER CARE INSTRUCTIONS

If you plan to be away from home, follow these instructions to ensure that the water quality of your spa is maintained:

SHORT TIME PERIODS (3-5 DAYS)

1. Adjust the pH by following the instructions outlined in the Water Quality and Maintenance section.
2. Sanitize the water by following the shock procedures also listed in the Water Quality and Maintenance section.
3. Lock your cover in place using the coverlocks.
4. Upon your return, sanitize the water by following the shock procedures, and balance the pH.
5. If Salt system is installed, please refer to Tips section, vacation or limited use in the Salt system Owner's Manual.

LONG TIME PERIODS (5-14 DAYS)

Prior to leaving:

1. At least one day before you leave, set the temperature to its lowest level. This setting should represent an approximate water temperature of 80°F (27°C).

IMPORTANT: Spa water oxidizers such as sodium dichlor (chlorine) maintain their level of effectiveness substantially longer in warm water 80°F (27°C) than in hot water 101°F to 104°F (38°C - 40°C).

2. Adjust the pH as required. Sanitize the water by following the shock procedures.

Upon your return:

3. Sanitize the water by following the shock procedures. Return the set temperature to its original setting. The spa water will be safe for you to use once the Free Available Chlorine residual level has dropped below 5.0 ppm.

IMPORTANT: If you will not be using your spa for an extended period of time (in excess of 14 days) and an outside maintenance service (or neighbor) is not available to assist with the water maintenance, draining or winterizing of the spa is recommended. Spas equipped with our **FRESHWATER III** ozone system can extend this to 4 weeks. The **FRESHWATER III** ozone system does not guard against possible freezing damage, however.

SUPPLEMENTAL WATER MAINTENANCE

Proper water sanitation and mineral balance (pH control) are absolutely essential for a complete spa water maintenance program. Here are two other popular water additives that are optional:

Mineral Deposit Inhibitors

As water evaporates from your spa and new water is added, the amount of dissolved minerals will increase. (Minimize evaporation by keeping the cover on the spa whenever possible.) The spa water may eventually become "hard" (calcium hardness too high) enough to damage the heater by calcifying its surface. Proper pH control can minimize this.

Normal soap build-up will require water replacement regularly enough that mineral deposits normally are not a problem.

Occasionally, high iron or copper content in the water may produce green or brown stains on the spa. A stain and scale inhibitor may help to reduce these metals.

IMPORTANT: Well water may contain high concentrations of minerals. The use of a low water volume, extra-fine pore water filter (in-line pre-filter such as the **CLEAN SCREEN** pre-filter) will help to remove many of the larger particles during the filling of the spa. In-line pre-filters can be purchased at your local **HOT SPRING** dealer.

Foam Inhibitors

Spa water requires changing due to the buildup of soap in the water. Typically, soap will cause the spa water to foam when the jets are used. Soap is introduced into the spa water from two sources: users' bodies, which retain a soap residual after showering, and swimming apparel, which retains soap after washing.

Foam inhibitors can suppress foam, but cannot remove soap from the water. Soap is very difficult to remove from the water because soap is not oxidized by any chemical added to the spa. Only ozone can oxidize soap.

Eventually the soap build-up in the water will be concentrated, resulting in an unclean feeling on the bather's skin, which is impossible to remedy. When this occurs, it's time to drain and refill the spa. Depending on the soap input, the water should last about four months before needing to be drained.

WATER TERMINOLOGY

The following chemical terms are used in this Water Quality and Maintenance section. Understanding their meaning will help you to better understand the water maintenance process.

Bromamines: Compounds formed when bromine combines with nitrogen from body oils, urine, perspiration, etc. Unlike chloramines, bromamines have no pungent odor, and are effective sanitizers.

Bromine: A halogen sanitizer (in the same chemical family as chlorine). Bromine is commonly used in stick, tablet, or granular form.

Calcium Hardness: The amount of dissolved calcium in the spa water. This should be approximately **75 - 150 ppm** (Salt System: **25 - 75 ppm**). High levels of calcium can cause cloudy water and scaling. Low levels can cause harm to the spa equipment.

Chloramines: Compounds formed when chlorine combines with nitrogen from body oils, urine, perspiration, etc. Chloramines can cause eye irritation as well as having a strong odor. Unlike bromamines, chloramines are weaker, slower sanitizers.

Chlorine: An efficient sanitizing chemical for spas. **WATKINS WELLNESS** recommends the use of sodium dichlor-type granulated chlorine. This type is preferred because it is totally soluble and nearly pH neutral.

Chlorine (or Bromine) Residual: The amount of chlorine or bromine remaining after chlorine or bromine demand has been satisfied. The residual is, therefore, the amount of sanitizer which is chemically available to kill bacteria, viruses and algae.

Corrosion: The gradual wearing away of metal and plastic spa parts, usually caused by chemical action. Generally, corrosion is caused by low pH or by water with levels of TA, CH, pH or sanitizer which are outside the recommended ranges.

Halogen: Any one of these five elements: fluorine, chlorine, bromine, iodine, and astatine.

MPS: Monopersulfate is the non-chlorine oxidizer used with the **FRESHWATER_{Ag+}** silver ion purification system. Not a sanitizer.

Nitric Acid: The formulation of nitric acid, a highly corrosive chemical, is a byproduct of the ozone generating process. Nitric acid is produced in very small quantities and is readily dissolved in the water stream with ozone.

Oxidizer: The use of an oxidizing chemical is to prevent the buildup of contaminants, maximize sanitizer efficiency, minimize combined chlorine and improve water clarity. See MPS and Ozone.

Ozone: Ozone is a powerful oxidizing agent which is produced in nature and artificially by man. Ozone forms no byproducts, oxidizes chloramines, and will not alter the water's pH.

pH: The measure of the spa water's acidity and alkalinity. The recommended pH for the spa water is 7.2 to 7.8. Below 7.0 (considered neutral), the spa water is too acidic and can damage the heating system. Above 7.8, the water is too alkaline and can result in cloudy water, and scale formation on the shell and heater.

ppm: The abbreviation of "parts per million", the standard measurement of chemical concentration in water. Identical to mg/l (milligrams per liter).

Reagent: A chemical material in liquid, powder, or tablet form for use in chemical testing.

Sanitizer: Sanitizers are added and maintained at recommended residuals to protect bathers against pathogenic organisms which can cause disease and infection in spa water.

Scale: Rough calcium-bearing deposits that can coat spa surfaces, heaters, plumbing lines, and clog filters. Generally, scaling is caused by mineral content combined with high pH. Additionally, scale forms more readily at higher water temperatures.

Super-Chlorination: Also known as "shock treatment." Super-Chlorination is a process of adding significant doses of a quick dissolving sanitizer ("dichlor" is recommended) to oxidize non-filterable organic waste and to remove chloramines and bromamines.

Total Alkalinity (TA): The amount of bicarbonates, carbonates, and hydroxides present in spa water. Proper total alkalinity is important for pH control. If the TA is too high, the pH is difficult to adjust. If the TA is too low, the pH will be difficult to hold at the proper level. The desired range of TA in spa water is 40 to 120 ppm.

OPERATING INSTRUCTIONS

The control panel provides a quick visual check of the spa's status and allows the user to set the temperature, activate the jets & lights, lock the temperature and/or spa functions. Other optional functions may also be available depending on the spa model and accessory equipment that has been installed into the spa. The control panel has eight buttons.

HARD BUTTONS

The four labeled outer buttons are referred to as "Hard buttons". These buttons are fixed and their functions do not change.

JETS - If jet pump indicator icon is off and JETS hard button is pressed, the 1st jet pump function will activate and the Control panel display will advance to the Jets menu.

If jet pump indicator icon is on and the JETS hard button is pressed while in any screen other than the Jets menu, the jets pump function does not change, only the Control panel screen will change to the Jets menu.

LIGHTS - If lights are off, press LIGHTS hard button from any screen to turn on the Underwater lights (only) and display the Underwater Lighting menu. When LIGHTS hard button is pressed in the Underwater Lighting menu with the underwater lights on, it will cycle the light intensity for the underwater lights. If underwater lights are on, initial press of LIGHTS hard button will not change light setting but will access Underwater lighting menu.

OPTIONS - Transitions to the Options screen to access temperature and setup menu

BACK - Goes back one menu. In Home screen Hold BACK button until screen rotates 180° to view from inside spa. Repeat to reverse.

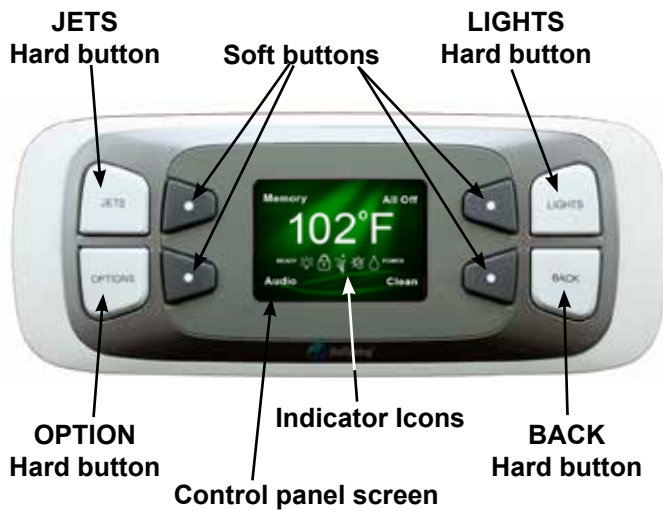

SOFT BUTTONS

The four inside buttons are referred to as "soft buttons". Pressing a soft button will activate the function on the control panel screen closest to that button. The control panel display lets you know you've pressed a button and that the selected function has been performed. After a period of non-use (45 seconds) the display will go back to the Home screen where the screen will remain on for several minutes before going into sleep mode. Pressing any button will wake up a sleeping display.

INDICATOR ICONS

The indicator icons can only be seen on the Home Screen. They are visible whenever the icon's function is active.

READY Indicator: The READY indicator icon is displayed when the spa water temperature is within 2°F (1°C) of the set temperature, and will turn off when the temperature is outside of that range. If you increase or decrease the temperature setting of the spa, the ready indicator will turn off until the water temperature reaches the acceptable range for the new temperature setting. A flashing READY indicator means a problem may exist with the temperature sensor (see Troubleshooting section for more information)

Spa Light Indicator: The Spa Light indicator icon is displayed when any light inside the spa is on. The indicator will remain solid as long as any light is activated. Spa Light indicator flashes whenever the color wheel is on.

Spa or Temperature Lock Indicator: The Spa or Temperature Lock indicator icon is displayed when either the Spa Lock, Temperature Lock or both is activated. Lock indicator icon does not flash.

Jet Pump Indicator: The Jet Pump indicator icon is displayed whenever a jet pump is on. The Jet Pump indicator icon will flash whenever the spa is in the ten-minute clean cycle.

Summer Timer Indicator: The Summer Timer indicator icon is displayed when the summer timer is set to ON. In the summer timer mode, the heater and circulation pump cycle are off for eight hours. The Summer Timer indicator icon will not flash.

Water Care Indicator: The Water Care indicator icon is displayed whenever a water care device is detected in the system and the water care system is operating correctly. The icon will flash if the water care system requires attention.

POWER Indicator: The POWER indicator icon is displayed when the spa is properly supplied with power. It also provides a diagnostic function—a flashing power indicator icon indicates that the heater high limit has tripped, meaning that either the spa water is above its acceptable temperature range, or a malfunction has occurred within the spa (such as low circulation due to clogged filters). An 'off' power indicator icon means that there is a problem with the spa control box or the power supplied to the spa (see Troubleshooting section for more information).

OPTION SCREEN

The Option screen is an intermediate screen that gets you to various optional settings.

Press the OPTIONS hard button on the control panel to display the Options screen.

Press the Soft button next to the descriptions to access the description's screen.

IMPORTANT: Audio, FRESHWATER Salt System will only be displayed on your Options screen if your spa is equipped with these features.

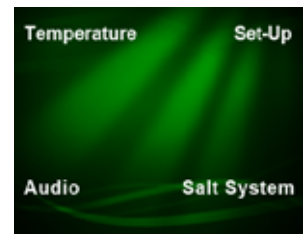

HOME SCREEN

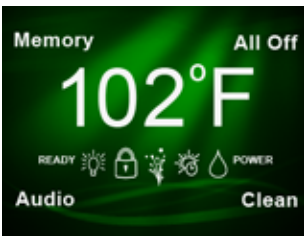

The temperature displayed in the center of the Home screen is the actual temperature of the spa water. If the READY icon is lit and solid on the screen then the actual spa temperature is within 2°F (1°C) of the set temperature. The corner soft button functions are as follows:

MEMORY

This feature will recall the last active setting for jets and lights prior to pressing the All Off button.

IMPORTANT: If the jet pump will not engage, make sure SPA LOCK is deactivated. SPA LOCK disables the controls on the control panel.

ALL OFF

This feature will shut all jets and lights off immediately, while saving the last active jets and lights settings.

AUDIO

If you purchased music or TV accessories with your spa, this feature will take you to the Audio menu.

CLEAN

Provided as a convenient timer for water maintenance, this function activates the jet pump on high for a ten minute period. The jet icon (on the Home Screen) will flash to indicate the jet pump is engaged and in the clean cycle. Next you may add properly measured spa water chemicals into the filter compartment. The jet pump and clean icon will automatically shut off after ten minutes.

IMPORTANT: Some soft key functions will only be displayed if the accessory has been installed.

TEMPERATURE CONTROL

The set temperature range is from 80°F to 104°F (26°C to 40°C). (The water temperature of any spa may rise or lower slightly depending on the current use and condition of your spa and on outside temperatures.)

The set temperature of the spa water will default to 100°F (38°C) the first time that power is applied. This is the setting programmed at the

factory. After the spa has been set up and used, the last temperature value set by the user will be stored in memory. If power is disconnected from the spa, it will automatically revert to the last set temperature when power is reapplied.

To display the set temperature of the spa:

- Press the OPTIONS hard button on the Control panel .
- Press the soft button next to **Temperature**. The set temperature screen will be displayed. This screen will automatically revert to the Home screen after 45 seconds of non-use.

To increase the set temperature of the spa water:

- Press the soft button next to ▲. Each time the button is pressed, the set temperature display will increase by one degree. If the button is held down, the set temperature display will increase by one degree every half-second.

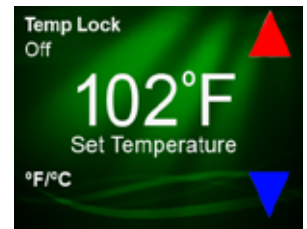

To decrease the set temperature of the spa water:

- Press the soft button next to ▼. Each time the button is pressed, the set temperature display will decrease by one degree. If the button is held down, the set temperature display will decrease by one degree every half-second.

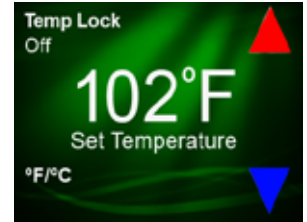

If the set temperature value does not change, check to see whether the

TEMP LOCK or SPA LOCK features are on. When either of these features is activated, the temperature control is disabled.

The temperature can be displayed in Fahrenheit or Celsius. Press the soft button next to the °F/°C to choose one or the other.

LOCKING FEATURES

The two locking features, Temperature Lock and Spa Lock, are activated at the Control panel. Once activated, a lock will remain active until the specific button combination is pressed to disable the lock. Even if power to the spa is disconnected even briefly, the lock will remain activated.

TEMPERATURE LOCK

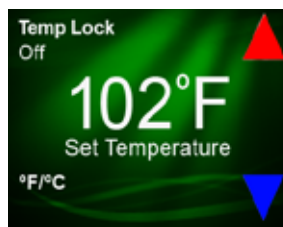

When activated, the Temperature Lock feature prevents a change in your desired water temperature setting. All other functions on the Control panel will operate normally while the temperature lock is "ON". This feature prevents others from changing the owner's desired settings.

To activate the Temperature Lock:

- Press the OPTIONS hard button at the Control panel.
- Press the soft button next to **Temperature** to advance the screen.
- Press the soft button next to **Temp Lock Off** to change the screen to **Temp Lock On**.

IMPORTANT: The Temperature/Spa lock icon will be displayed on the Home Screen during a temperature lock condition.

To deactivate the Temperature Lock:

- Press the OPTIONS hard button at the Control panel.
- Press the soft button next to **Temp Lock**.
- Press the soft button next to **Temp Lock On** to change the screen to **Temp Lock Off** to turn the Temp Lock and icon off.

SPA LOCK



When activated, the Spa Lock feature disables all functions on the control panel. It prevents others from tampering with the jets, lights and temperature settings on your spa. The control panel will not respond to any hard or soft buttons when pushed in Spa Lock mode.

To activate the Spa Lock:

- Press the **OPTIONS** hard button.
- Press the soft button next to **Set-up**.
- Press the soft button next to **Spa Lock Off**.

IMPORTANT: The Temperature/Spa Lock icon will be displayed while the screens are locked.

To deactivate the Spa Lock:

- Press and hold the **OPTIONS** hard button and the **LIGHTS** hard button at the same time for 3 seconds. The spa lock icon will turn off.

IMPORTANT: You can activate the spa lock feature even when the temperature lock is already on. You do not need to turn off the temperature lock in order to turn on the spa lock feature. If the temperature lock was already on when you activate the spa lock, it will remain on when you turn off the spa lock.

JETS CONTROL



The **JETS** hard button activates the jet pumps. When the **JETS** hard button is pressed, the jets menu will be displayed on the control panel with Jet 1 in the Low position, the Jet Pump icon will also display on the home screen. Press any of the soft keys to change the jet functions between high or low (when available) speed, and off.

The **PRISM** model has 3 jet pumps, Jet 3 can be found in the lower right corner of the jets screen (not illustrated). The third jet pump can only be activated by pressing the soft key next to Jet 3.

The jets icon (on the Home Screen) will remain lit until the button is pressed to turn off the jet pump(s), or after two hours of continuous operation when the pump(s) is automatically shut off by the control system.

The jet pump(s) will turn themselves off after two hours of continuous operation to prevent overheating and conserve energy in case you forgot they were on. The jets can be restarted again with no delay.

IMPORTANT: The jet pumps will not function while the spa lock feature is activated.

You may also run through the entire jet pump cycle by only using the **JETS** hard button as follows:

PRISM , PULSE, FLAIR & FLASH

1st Press = Jet pump 1 on Low	2nd Press = Jet pump 1 on High
3rd Press = Both jet pumps on high speed	4th Press = Jet pump 1 on Low, Jet pump 2 on high
5th Press = Jet pump 2 on High	6th Press = All pumps off

BEAM

1st press = jet pump on High	2nd press = jet pump OFF
------------------------------	--------------------------

LIGHT CONTROL

All **HOT SPRING** spas are equipped with Multi-Color lighting.

Pressing the **LIGHTS** hard button will turn on both the Interior and Exterior lights.

IMPORTANT: Pressing the hard light button a second time will dim interior to 2, press hard light button a third time will dim interior to 1, press hard light button a fourth time will dim interior to off, press the hard light button a fifth time will shut all lights off.

Using the screen to change the intensity of the spa's Interior lights:

- Press the soft button next to **Dimmer**. There are three (3) brightness levels plus off.

IMPORTANT: Pressing the **LIGHTS** hard button several times will also change the intensity of the spa's Interior lights when in the Interior Lights screen from brightest to off, back to brightest.



To change the color of the Interior lights:

- Press the soft button next to **Color**. The colors are as follows: 1) Blue, 2) Aqua, 3) Green, 4) White, 5) Yellow, 6) Red, 7) Magenta, 8) Color Wheel On, 9) Color Wheel Off.

NOTE: Lights icon on the Home Screen will flash whenever the Color Wheel is on.

Press **Lights Off** To turn off all of the lights:

Exterior lights:

- Press the soft button next to **Exterior Lights** to view the Exterior Lights screen.
- For **Dimmer** and **Color** functions see Interior Lights information above.
- Press the soft button next to **Daily Lights** to turn on the 24 hour external light time. Activating the timer will turn external lights on for 6 hours at the same time every day.
- Press the soft button next to **Daily Lights** a second time to turn the timer Off
- Press the soft button next to **Interior Lights** to return to the Interior Lights menu.



SUMMER TIMER

Your **HOT SPRING** spa is equipped with a summer timer. The summer timer can be activated during extremely hot summer months to maintain water temperatures. Activating the summer timer causes the heater to immediately shut down. The circulation pump will remain on for approximately 5 minutes pushing water through the heater to cool it down. Both heater and circulation pump will then remain off for eight hours. The summer time icon will be displayed on the control panel and will remain displayed for as long as the summer timer is on. The circulation pump and heater will automatically shut down for the same eight hours every day until the summer timer is deactivated. It is recommended to activate the summer timer in the morning so that the spa is off during the hottest part of the day and so that the circulation pump will start up again in the evening when you are ready to enjoy the spa again.

IMPORTANT: The Summer timer will not lower the spa's water temperature below the ambient air temperature. Ambient conditions, including humidity, wind and shading will affect your spa water temperature.

To activate the Summer timer, simply follow these steps:

- Press the **OPTIONS** Hard button on the Control panel.
- Press the soft button next to **Set up**.
- Press the soft button next to **Summer timer** to activate. The Summer timer icon (on the Home Screen) will display when activated.

IMPORTANT: If water temperature falls below 80°F (26.7°C) the summer timer will automatically be disabled.

- The Summer timer should be deactivated when cooler temperatures return. To do this, simply repeat last 3 steps. The yellow Summer timer icon will turn off.



BRIGHTNESS

If you would like to change the brightness of the control panel screen:

- Press the **OPTIONS** hard button on the Control panel.
- Press the soft button next to **Set-up**.
- Press the soft button next to **Brightness** to lower the brightness from 7 down to 1.



IMPORTANT: Pressing the Brightness soft button at number 1 will increase the screen brightness back to 7.

LANGUAGE

The Control panel screen can be viewed in seven different languages. The languages are English, French, German, Dutch, Swedish, Norwegian, and Spanish. To change languages:

- Press the **OPTIONS** hard button on the Control panel.
- Press the soft button next to **Set-Up**.
- Press the soft button next to **More**
- Press the soft button next to **Language** until the desired language is visible.

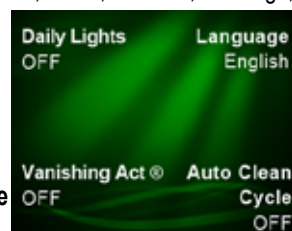

IMPORTANT: Should you accidentally change the language screen into a language you don't know, simply repeat the previous steps where Set-up is in the top right corner and Language is in the lower right corner.

AUTO CLEAN CYCLE

The Auto Clean Cycle will activate the jets for 10 minutes total time every 24 hours starting at the time ON was first pressed.

- Press the **OPTIONS** hard button on the Control panel.
- Press the soft button next to **Set-Up**
- Press the soft button next to **More**
- Press the soft button next to **Auto Clean Cycle**



VANISHING ACT CYCLE

The **VANISHING ACT** Cycle will activate the jets for 6 hours, ONLY to be used with **VANISHING ACT** (see page 11)

- Press the **OPTIONS** hard button on the Control panel.
- Press the soft button next to **Set-Up**
- Press the soft button next to **More**
- Press the soft button next to **VANISHING ACT**

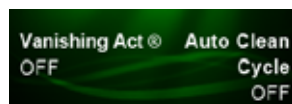

FRESHWATER SALT SYSTEM (OPTIONAL)

If your spa has the **FRESHWATER** Salt System installed you can navigate to the screen as follows:

- Press the **OPTIONS** hard button on the Control panel.
- Press the soft button next to **FRESHWATER** Salt System.

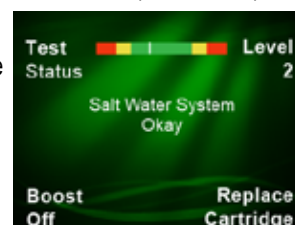

(see **FRESHWATER** Salt System owner's manual for more information).

AUDIO (OPTIONAL)

If a wireless audio sound system is installed, both the Home screen and the Options screen will display the Audio function.

To enter the Audio menu screen:

- Press the soft button next to **Audio**.

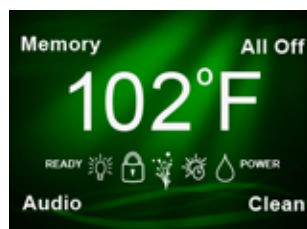

TO TURN AUDIO SYSTEM ON/OFF

- Press the soft button next to **Audio OFF** to turn the Sound System on or off next to **Audio ON**. Audio must be ON to advance the audio screens.

TO PAIR BLUETOOTH

1. Press the **Function:SET** soft button 3 times to advance to the **Enter Setup** screen. Press the **Enter Setup** soft button to advance to the **Setup Source** screen. Bluetooth should be selected.
2. Press **SETUP Source** soft button 6 times from **SETUP Source** screen to advance to the **PAIR** screen.
3. Press **PAIR** soft button followed by pressing "connect" next to *My Spa BTRX* on your device to pair. If you do not see this, another device may already be connected (see To Disconnect Bluetooth on following page).



After pairing, you will be ready to use your Bluetooth device. Only one paired Bluetooth device will work at a time.

TO ADJUST VOLUME

- Press the soft button next to ▲ or ▼ to change the volume level.
- Press the **Function:SET** soft button to advance to the Play/Pause function screen.



TO PAUSE/PLAY (SONG)

- Press the soft button next to **PLAY/PAUSE** (top right corner) to play or pause music.
- Press the **Function:PLAY/PAUSE** soft button to advance to the TRACK function screen.

NOTE: Some audio sources will display song title.

- Press the **Function:SET** soft button to advance to the Forward function screen.

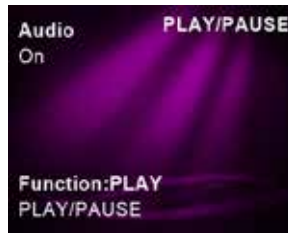

TO CHANGE TRACK (SONG)

- Press the **FORWARD** or **BACK** soft buttons to change the track (song).
- Press the **Function:TRACK** soft button to advance to the SETUP function screen.
- Press the **Function:SET** soft button to advance to the Enter Setup screen.



TO GO TO SETUP MENU

- Press the **ENTER SETUP** soft button to scroll to the **SETUP SOURCE** screen.
- IMPORTANT:** If the **Function: SETUP** soft button is pressed, the screen will advance back to the Volume screen. Press the Back hard button to exit audio screens if desired.



TO CHANGE AUDIO SOURCE

- This Source screen illustrates the current audio source the spa is using.
- Press **▲** or **▼** soft buttons to change the desired source: TV, AUX or Bluetooth®.

To use the Bluetooth screen, your audio Bluetooth device must be paired with the spa.



TO ADJUST TREBLE

- Press **SETUP SOURCE** soft button to advance to the SETUP Tone, Treble screen.
- Press the soft button next to **▲** or **▼** to change the Treble between -5 and +5.
- Press **SETUP Tone, Treble** soft button to advance to the Tone, Bass screen.



TO ADJUST BASS

- Press the soft button next to **▲** or **▼** to change the Bass between -5 and +5.
- Press **SETUP Tone, Bass** soft button to advance to the BALANCE screen.



TO ADJUST BALANCE

- Press the soft button next to **▲** or **▼** to change the Balance between -5 and +5.
- Press **SETUP Balance** soft button to advance to the Subwoofer Volume screen.



TO ADJUST SUBWOOFER

- Press the soft button next to **▲** or **▼** to change the Subwoofer Volume between 0 and 11.
- Press **SETUP Subwoofer** soft button to advance to the Reset screen.



TO DISCONNECT BLUETOOTH (RESET)

- Press the soft button next to **Reset** to disconnect any device using the spa music system so that another paired device may be used. This is also necessary when trying to pair multiple devices because pairing is NOT possible when another device is connected to the music system.
- Press **SETUP Music Status** soft button to advance to the Pair screen.
- To pair, press **PAIR** soft button followed by pressing "connect" next to *My Spa BTRX* on your device.

IMPORTANT: Use the BACK hardbutton to go back to the **Function:SET** screens if desired.



JET MENUS

PRISM (MODEL PSM)

Jet Pump 1 - Jet System 1 Diverter lever in the position

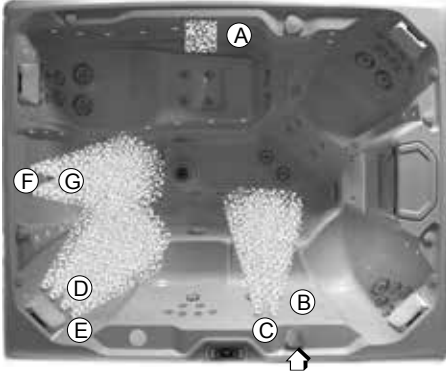

- a. 1 Waterfall (lever must be in ON position)
- b. 2 Standard Single Rotary jets
- c. 4 Directional **PRECISION** jets
- d. 6 Directional **PRECISION** jets
- e. 4 Rotary **PRECISION** jets
- f. 4 Rotary **PRECISION** jets
- g. 1 XL Dual Rotary jet

Jet Pump 1 - Jet System 2 Diverter lever in the position

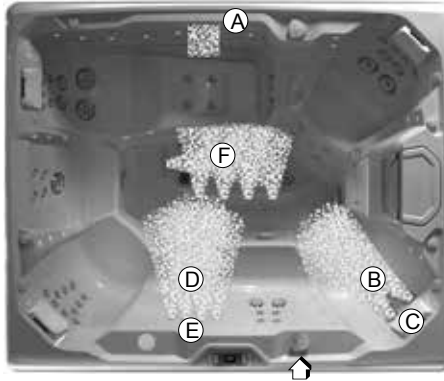

- a. 1 Waterfall (lever must be in ON position)
- b. 1 XL Directional jets
- c. 4 Standard Dual Rotary jets
- d. 1 Standard Dual Rotary jets
- e. 6 Directional **PRECISION** jets
- f. 5 Directional **PRECISION** jets

Jet Pump 2

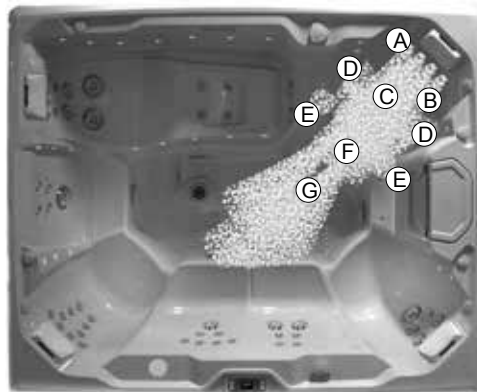

- a. 4 Directional **PRECISION** jets
- b. 2 Standard Single Rotary jets
- c. 2 XL Directional jets
- d. 2 Directional **PRECISION** jets
- e. 2 Rotary **PRECISION** jets
- f. 4 Directional **PRECISION** jets
- g. 2 Standard Directional jets

Jet Pump 3 - Jet System 1 Diverter lever in the position

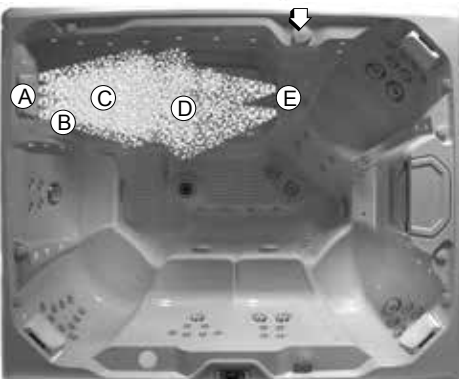

- a. 6 Directional **PRECISION** jets
- b. 2 Standard Dual Rotary jets
- c. 2 XL Single Rotary jets
- d. 4 Directional **PRECISION** jets
- e. 2 Standard Directional jets

Jet Pump 3 - Jet System 2 Diverter lever in the position

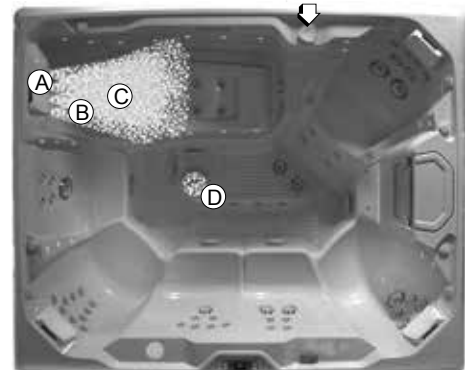

- a. 6 Directional **PRECISION** jets
- b. 2 Standard Dual Rotary jets
- c. 2 XL Single Rotary jets
- d. 1 XXL Jet

JET MENUS

PULSE (MODEL PLS)

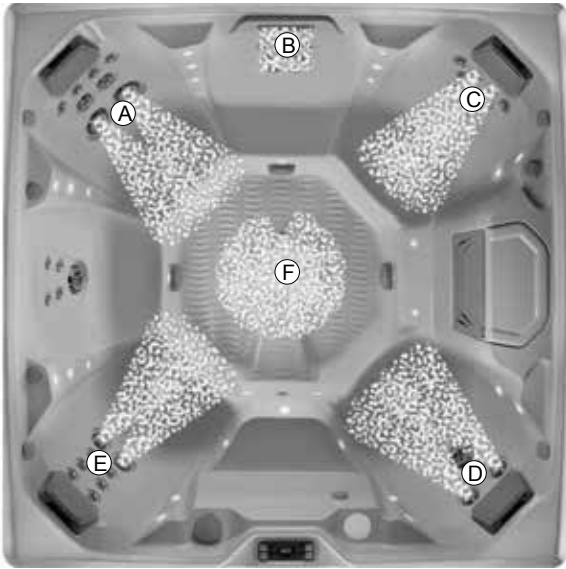

Jet Pump 1

- a. 2 XL Directional jets
- b. 1 Water Feature (lever must be in ON position)
- c. 2 Directional **PRECISION** jets
- d. 2 Standard Single Rotary jets
- e. 2 Standard Directional jets
- f. 7 Directional **PRECISION** jets

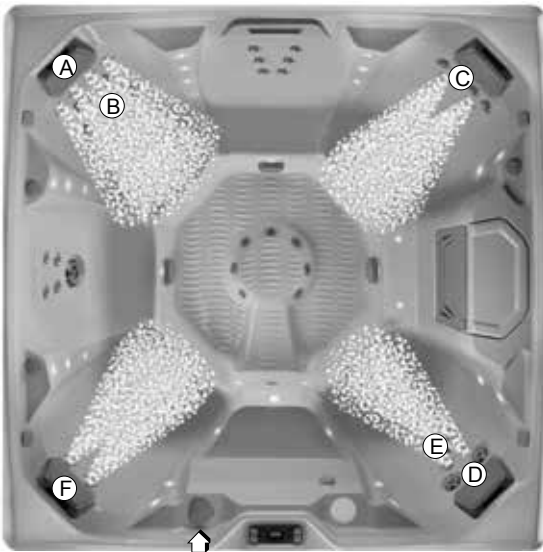

Jet Pump 2 - Jet System 1

Diverter lever in the  position

- a. 4 Directional **PRECISION** jets
- b. 2 Standard Single Rotary jets
- c. 6 Directional **PRECISION** jets
- d. 2 Directional **PRECISION** jets
- e. 1 XL Single Rotary jets
- f. 6 Directional **PRECISION** jets

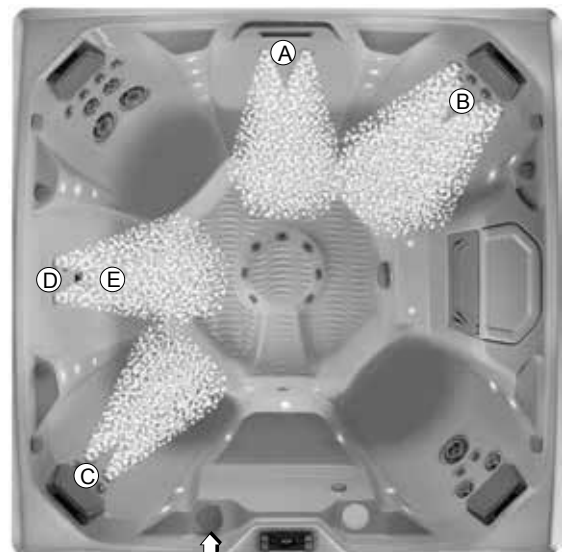

Jet Pump 2 - Jet System 2

Diverter lever in the  position

- a. 6 Directional **PRECISION** jets
- b. 8 Directional **PRECISION** jets
- c. 4 Directional **PRECISION** jets
- d. 4 Rotary **PRECISION** jets
- e. 1 XL Dual Rotary jet

JET MENUS

FLAIR (MODEL FLR)

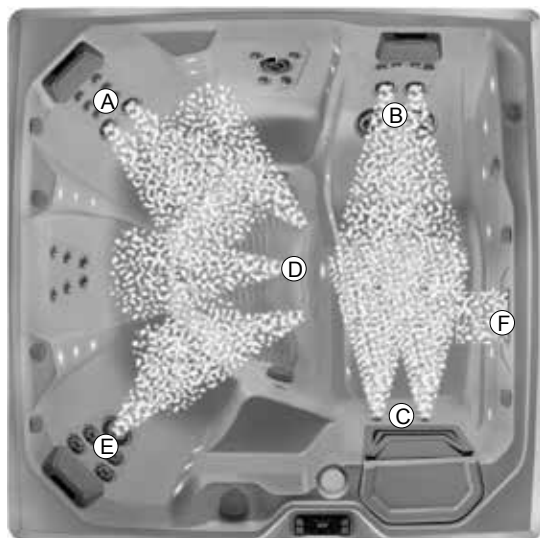

Jet Pump 1

- a. 2 Standard Directional jets
- b. 2 Standard Dual Rotary jets
- c. 4 Directional **PRECISION** jets
- d. 3 Standard Directional jets
- e. 1 XL Directional jets
- f. 1 Water Feature (lever must be in ON position)



Jet Pump 2 - Jet System 1

Diverter lever in the  position

- a. 2 Directional **PRECISION** jets
- b. 1 XL Dual Rotary jet
- c. 2 Directional **PRECISION** jets
- d. 4 Directional **PRECISION** jets
- e. 2 XL Single Rotary jets
- f. 4 Directional **PRECISION** jets



Jet Pump 2 - Jet System 2

Diverter lever in the  position

- a. 6 Directional **PRECISION** jets
- b. 2 Standard Dual Rotary jets
- c. 2 Standard Directional jets
- d. 2 Directional **PRECISION** jets
- e. 4 Directional **PRECISION** jets

JET MENUS

FLASH (MODEL FSH)

Jet Pump 1

- a. 2 Standard Single Rotary jets
- b. 1 Water Feature (Lever must be in ON position)
- c. 4 Directional **PRECISION** jets
- d. 4 Directional **PRECISION** jets
- e. 2 Standard Directional jets
- f. 1 XL Directional jet

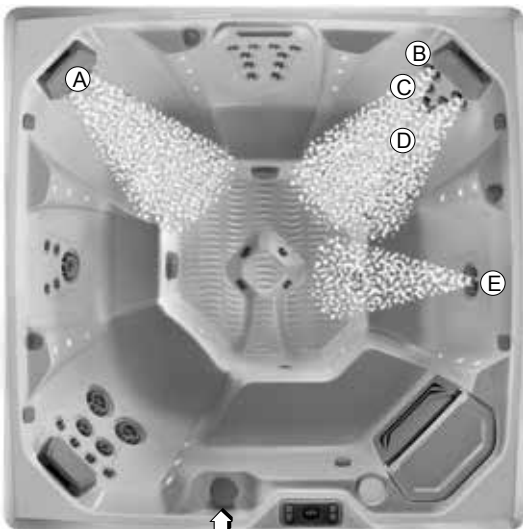
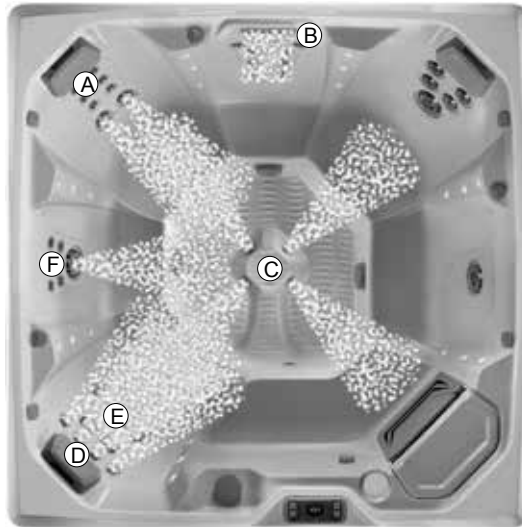

Jet Pump 2 - Jet System 1

Diverter lever in the  position

- a. 6 Directional **PRECISION** jets
- b. 2 Standard Single Rotary jets
- c. 2 Standard Directional jets
- d. 1 XL Rotary jet
- e. 1 XL Directional jet

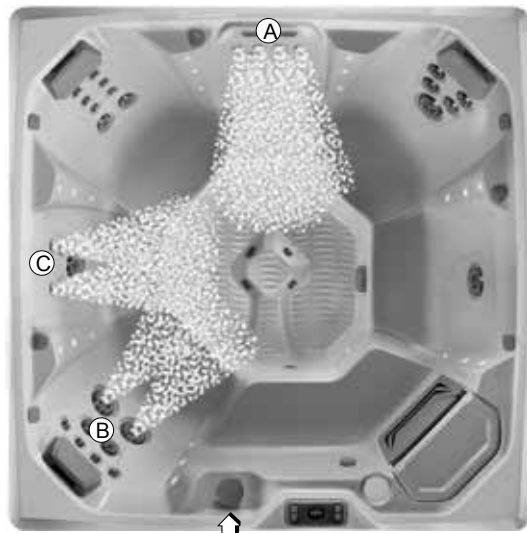

Jet Pump 2 - Jet System 2

Diverter lever in the  position

- a. 10 Directional **PRECISION** jets
- b. 2 XL Rotary jets
- c. 4 Directional **PRECISION** jets

JET MENUS

BEAM 220V (MODEL BMII)

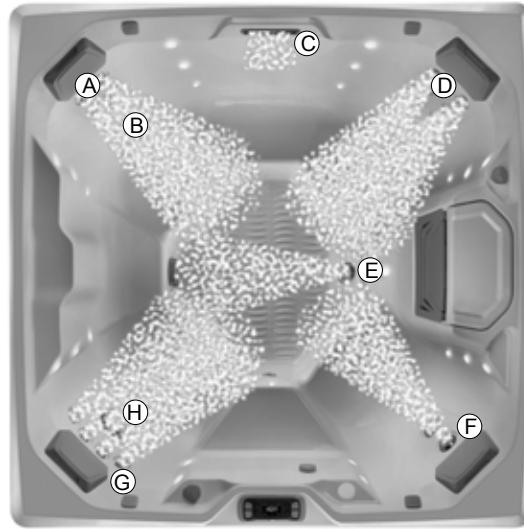

Jet Pump

- a. 4 Directional **PRECISION** jets
- b. 1 Standard Directional jet
- c. 1 Water Feature (Lever must be in ON position)
- d. 6 Directional **PRECISION** jets
- e. 1 Standard Directional jet
- f. 2 Standard Single Rotary jets
- g. 4 Directional **PRECISION** jets
- h. 1 XL Directional jet

BEAM 115V (MODEL BMI)

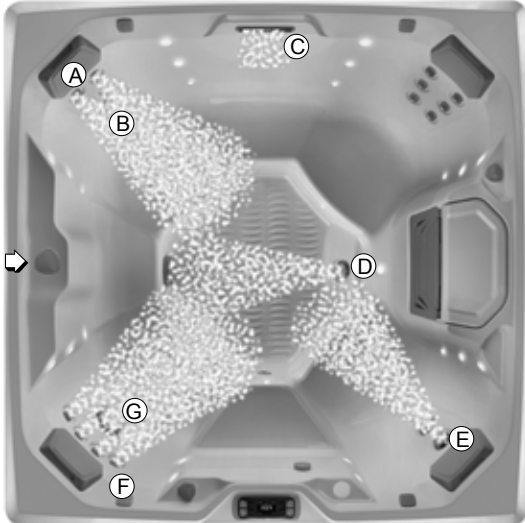

Jet System 1

Diverter lever in the **1** position

- a. 4 Directional **PRECISION** jets
- b. 1 Standard Directional jets
- c. 1 Water Feature (Lever must be in ON position)
- d. 1 Standard Directional jet
- e. 2 Standard Single Rotary jets
- f. 4 Directional **PRECISION** jets
- g. 1 XL Directional jet

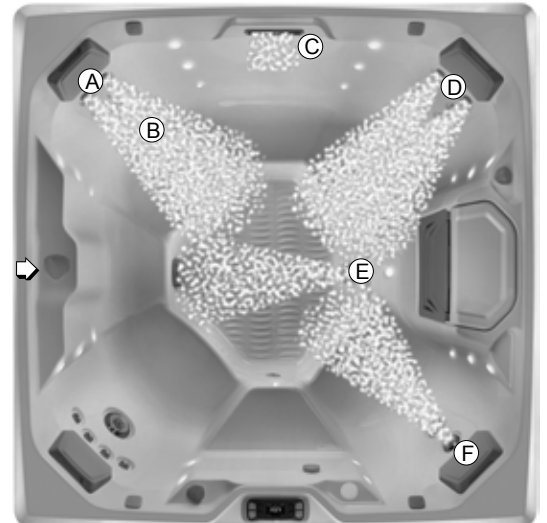

Jet System 2

Diverter lever in the **2** position

- a. 4 Directional **PRECISION** jets
- b. 1 Standard Directional jet
- c. 1 Water Feature (Lever must be in ON position)
- d. 6 Directional **PRECISION** jets
- e. 1 Standard Directional jet
- f. 2 Standard Single Rotary jets

SPA CARE AND MAINTENANCE

Your **HOT SPRING** spa is manufactured from the highest quality, most durable materials available. Even so, the spa care and maintenance program you develop will ultimately determine how long your spa, and its individual components, will last. Regular maintenance and following the advice in this section will help you to protect your investment.

DRAIN & REFILL INSTRUCTIONS

IMPORTANT: It is NOT recommended to refill your spa when the ambient temperature goes below 50° F (10° C).

1. Disconnect the spa from the power supply by tripping both of the GFCI breakers located in the subpanel. Unplug power cord for 115V models.
2. Locate the drain valve (below front panel) for the spa and remove the drain cap. Attach the inlet of a garden hose to the drain valve (to avoid flooding of the foundation surrounding the spa) and route the outlet of the hose to an appropriate draining area. Spa water with a high sanitizer level may harm plants and grass.
3. Open the valve by turning the knob. The spa will drain by gravitational flow.
4. Allow all of the water to drain through the drain.
5. When empty, inspect the spa shell and clean as required. (Follow the Care of the Exterior instructions.)
6. Close the drain valve and reinstall the drain cap.
7. Install new filters or clean existing with **FRESHWATER** filter cleaner. **IMPORTANT:** Always clean and rotate the filter cartridges each time the spa is drained for cleaning.
8. Refill the spa through the filter compartment using the **CLEAN SCREEN** pre-filter. **IMPORTANT:** Refill water temperature must be between 50° - 70°F to avoid high-limit tripping.
9. Follow the Quick Start-Up instructions in the Getting Started section.

COLD WATER REFILL

- When refilling your spa if the tap water is below 50° F (10° C) the spa may go into a High Limit Protection mode (causing your spa to stop functioning). If high limit tripping does occur, the fastest way to reactivate the spa control system is to first disconnect power to the spa completely, then warm the two sensors on top of the heater and the vinyl tubing (located in the equipment compartment) with a hair dryer for approximately 10 minutes. Once you believe the sensors and heater tubing have been warmed sufficiently, reconnect power to the spa.
- Blending warm water with the cold tap water so it exceeds 50° F (10° C) during the refilling process will also achieve the same results if that is an option for you.



PREVENTION OF FREEZING

Your spa has been designed and engineered for year-round use in any climate. In some areas, extremely cold temperatures below 10°F (-12°C) combined with strong wind, may cause partial freezing of the jet pump, even though the water inside the spa remains at the selected temperature. The energy efficiency of the spa may also

decrease during these cold periods, as the heater will cycle more frequently. As an additional precaution against partial freezing of some of the components, the equipment compartment can be insulated with an insulating kit (available from your local dealer). This insulating kit will also help to maximize the spa's energy efficiency.

IMPORTANT: When warmer weather returns approx. 60°-70°F (15° - 21°C), the insulating kit must be removed to prevent overheating of the jet pump.

WINTERIZING YOUR SPA

If you leave the spa unused for a long period of time in severely cold weather, you should drain the spa and winterize it to avoid accidental freezing due to a power or equipment failure.

Use only Propylene Glycol as your anti-freeze (available at most RV or marine supply stores). This is non-toxic.

⚠ DANGER: Never use an automobile anti-freeze (Ethylene Glycol) since it is toxic!

⚠ WARNING: Failure to follow these instructions correctly can lead to freeze damage not covered by warranty. It is strongly recommended that you contact your local dealer to perform this service

1. Drain your spa following the Drain & Refill instructions steps 1-5. Open waterfall valve.
2. Remove the filter cartridges, clean and store in a dry place.
3. Rotate diverter levers to middle position and Water Feature lever to open position.

IMPORTANT: These additional instructions must be utilized when draining and winterizing your spa in climates where the temperature falls below 32°F (0°C). A five (5) gallon combination (vacuum/blower) wet/dry shop vac must be used to effectively remove water that is trapped inside the plumbing lines.

4. Attach the vacuum's hose to the blower side of the shop vac.
 - a. Place the end of the vacuum hose down the filter opening.
 - b. Turn on the blower function and allow it to blow out any water remaining in the plumbing lines (approximately 3 to 5 minutes).
 - c. Turn the **SMARTJET** lever to the second position and allow that system to purge.
 - d. If your spa is equipped with more than two jet systems, then each jet system will also need to be blown out.
5. Attach the vacuum hose to the vacuum side of the shop vac. Vacuum all openings and orifices as follows:
 - a. Jet openings: start with the jets at the top and move downward (if suction is coming from another jet, block off the other jet using a large rag – this will help pull out the water that is trapped deeper inside the main line)
 - b. Filter suction fittings and filter compartment.
 - c. Drain outlet (it may be necessary to cover the drain grate tightly with a rag when vacuuming the drain outlets to ensure water is drawn completely from the internal plumbing system).
6. Thoroughly dry the spa shell with a clean towel.
7. Replace the drain cap.

Use only Propylene Glycol as your anti-freeze. This is non-toxic.

8. Using a long-extension funnel, pour anti-freeze into all standpipes, filter suction fittings, jet orifices and water feature orifices. Add enough anti-freeze to ensure adequate protection – in many cases,

you will see the liquid in the orifice, or coming out of another location.

9. Close the spa cover and fasten the cover tie downs. Cover the spa cover with two pieces of plywood to evenly distribute the weight of snow and ice. Secure a plastic sheet, or tarp, over the spa cover and plywood.
10. Replace the equipment access door, if removed.

OPENING INSTRUCTIONS:

1. Remove plywood and plastic sheet. Open the spa cover by unfastening the cover tie downs.
2. Follow the Start-up and Refill Procedures in the Operating Instructions section of the Owner's Manual. Do not install filters to prevent them from exposure to the anti-freeze.
3. As part of this process, superchlorinate the spa water by adding three teaspoons of chlorine (sodium dichlor) per 250 gallons of spa water into the filter compartment. This is twice the normal amount of chlorine needed for superchlorination. This extra amount of chlorine is needed to destroy the anti-freeze.

NOTE: A defoamer may be needed to decrease the amount of foam caused by the anti-freeze

4. Drain your spa to ensure removal of anti-freeze. Do not drain water on grass or plants due to excessive chlorine level.
5. After the spa has completely drained, re-install your filter and follow the Start-up and Refill Procedures in the Operating Instructions section of the Owner's Manual.

IMPORTANT: Always keep spa covered when not in use, whether it is empty or full.

FILTER SYSTEM

The filter lid on the spa is NOT designed to support heavy weight loads and should not be used as a seat. In extreme cases, the lid could crack and break. This occurrence is considered abuse and is not covered under the warranty.

LIMELIGHT Collection spas are equipped with two filter cartridges, sized to meet the needs of the jet pump system.

As with any water filtering system, the filter cartridges may become clogged, resulting in reduced water flow. It is important to maintain a clean, unobstructed filtering system. This not only provides the maximum performance from the jets, but allows the 24 hour filtration system to function effectively. **WATKINS WELLNESS** recommends the filter cartridges be cleaned (by soaking in a filter cleaner to dissolve minerals) at least once every month.

IMPORTANT: The frequency and duration of use, and the number of occupants all contribute to determining the appropriate time between filter cleanings. More use means that more frequent filter cleanings are required. Failure to maintain the cartridges in a clean, unobstructed manner will result in reduced water flow through the heater assembly that may cause the High-Limit Thermostat, Heater Thermal Cut-off or Circulation Pump Thermal Cut-off to trip. If this high-limit or thermal cut-off trip occurs during sub-freezing temperatures and goes unnoticed, the spa water may freeze. Any damage to the spa (due to freezing) caused as a result of poor maintenance (stated under misuse or abuse in the **HOT SPRING** spa Limited Warranty), will not be covered by your spa warranty.

⚠ WARNING: To reduce the risk of injury to persons using the spa, DO NOT remove the suction fittings (filter standpipes) located in the filter compartment and do not sit on the filter lid, in extreme cases the lid could crack and break.

SECONDARY SUCTION SCREEN

Located in the foot well of your spa are three secondary suction screens. The screen is used as a filter to prevent dirt from circulating through the system.

⚠ WARNING: Do not use the spa with the suction screens removed.

FILTER CARTRIDGES REMOVAL & CLEANING

1. Disconnect the spa from the power supply by tripping both of the GFCI breakers located in the subpanel. Unplug power cord for 115V models.
2. Remove and carefully set aside the filter compartment cover.
3. Remove any floating items from within the filter compartment.
4. Turn the filter retainer handle (located on the top of the filter cartridge) counterclockwise until the retainer can be removed from the filter standpipe.
5. Remove the filter retainer and cartridge.
IMPORTANT: Never remove the filter standpipes when debris is present in the filter compartment. Debris may find its way into the internal plumbing which may result in blockage. NEVER REMOVE SUCTION FITTINGS.
6. Always clean standard filter using a filter degreaser, such as **FRESHWATER** Filter Cleaner, to remove mineral and oil buildup. Simply soak the filter in the degreaser according to the package directions, then place the filter on a clean surface and spray until clean using a garden hose. It may be necessary to rotate the filter while spraying to remove any debris lodged between the filter pleats.
7. To reinstall the filter cartridge, reverse the order of steps in which it was removed. Do not overtighten!

⚠ WARNING: Do not use the spa with the filter cartridges, or filter standpipe(s) removed!

CARE OF THE SPA PILLOWS

The spa pillows will provide years of comfort if treated with care. They have been positioned above the water level to minimize the bleaching effects of chlorinated water, and other spa water chemicals. To extend their life, whenever the spa shell is being cleaned, the spa pillows should be removed and cleaned. Body oils can be removed with a mild soap and water solution. ALWAYS rinse off the spa pillows thoroughly to remove any soap residue. The pillows can be conditioned with **HOT SPRING** Cover Shield after cleaning. If the spa is not going to be used for a long period of time (that is during a vacation, or if the spa is winterized), or when the spa water is being super-chlorinated, the spa pillows should be removed until the next spa use.

To remove and replace the spa pillows:

1. Carefully pull and lift on one end of pillow to stretch pillow (longer) until the pillow is released from the plastic retainer. Once one end is released, push pillow in opposite direction to remove from other retainer.
2. Align pillow.
3. Slide one end of pillow onto the spa retainer.
4. Pull other end of pillow; using both hands lift pillow above retainer and with a stretching motion slide pillow recess onto retainer.

CARE OF THE EXTERIOR

SPA SHELL

Your **HOT SPRING** spa has an acrylic shell. Stains and dirt generally will not adhere to your spa's surface. A soft rag or a nylon scrubber should easily remove most dirt. Most household chemicals are harmful to your spa's shell (see below for detailed information on cleaning agents). Always rinse off any spa shell cleaning agent with fresh water.

IMPORTANT:

1. The following products are the **ONLY** approved cleaning agents for your **HOT SPRING** spa shell: plain water, **HOT SPRING FRESHWATER** Spa Shine, or Soft Scrub®. The use of alcohol or any other household cleaner other than those listed to clean the spa shell surface is **NOT** recommended. **DO NOT** use any cleaning products containing abrasives or solvents since they may damage the shell surface, specifically: Simple Green®, Windex® or Spa Mitt. **NEVER USE HARSH CHEMICALS!** Damage to the shell by use of harsh chemicals is not covered under the warranty. Always rinse off any spa shell cleaning agent with fresh water.
2. Iron and copper in the water can stain the spa shell if allowed to go unchecked. Ask your **HOT SPRING** dealer about a Stain and Scale Inhibitor to use if your spa has a high concentration of dissolved minerals. (**WATKINS WELLNESS** recommends **FRESHWATER** Stain & Scale Defense.)
3. Keep all cleaners out of the reach of children and use care when applying.

EVERWOOD® SPA CABINET

HOT SPRING spas include an **EVERWOOD** spa cabinet. **EVERWOOD** consists of a rigid polymer with an exterior acrylic film that combines the durability of plastic with the beauty of real wood.

Cleaning of **EVERWOOD** consists of simply spraying the cabinet with a mild soap and water solution to remove any stains and residue.

Do not rub the **EVERWOOD** with an abrasive material or use abrasive cleaners as this may damage its texture.

CARE OF THE SPA COVER

⚠ WARNING: The cover is a manual safety cover that meets or exceeds all prevailing requirements of ASTM 1346-91 for spa safety covers when installed and used correctly as of the date of manufacture. Non-secured, or improperly secured covers are a hazard.

Open the cover to its fully open position before use.

VINYL COVER

The vinyl spa cover is an attractive, durable foam insulation product. Monthly cleaning and conditioning are recommended to maintain its beauty.

To clean and condition the vinyl cover:

1. Remove the cover from the spa and gently lean it against a wall or fence.
2. With a garden hose, spray the cover to loosen and rinse away dirt or debris.
3. Using a large sponge and/or a soft bristle brush, and using a very mild soap solution (one teaspoon dishwashing liquid with two gallons of water), or baking soda (sodium bicarbonate), scrub the vinyl top in a circular motion. Do not let the vinyl dry with a soap film on it before it can be rinsed clean.

4. Scrub the cover's perimeter and side flaps. Rinse clean with water.
5. Rinse off the underside of the cover with water only (use no soap), and wipe it clean with a dry rag.
6. To condition the cover after cleaning, apply a thin film of **HOT SPRING** Cover Shield to the vinyl surface and buff to a high luster.

IMPORTANT: To remove tree sap, use cigarette lighter fluid (not charcoal lighter fluid). Use sparingly, and rinse with a saddle soap solution immediately afterwards, then wipe dry.

DO:

- Remove snow buildup to avoid breakage of the foam core from the additional weight of the snow.
- Lock cover lock straps to secure the cover when the spa is not in use.

DON'T:

- Drag or lift the spa cover using either the flaps, or the cover lock straps.
- Walk, stand, or sit on the cover.
- Place any metal or heat transferring object on the cover or place any type of plastic tarp or drop cloth over the cover as this may result in a melted foam core, which would not be covered under the warranty.
- Use any lifting mechanisms, chemicals, or cleaners except those recommended by **WATKINS WELLNESS**, or its Authorized Sales and Service Dealer.

COVER LIFTER SYSTEM

Clearance required behind cover when open:

CoverCradle® & CoverCradle II 24" (61 cm)	UpRite® 7" (18 cm)	Lift 'n Glide® 14" (36 cm)
--	-----------------------	-------------------------------

HOW TO OPEN THE VINYL COVER

IMPORTANT: Never attempt to open or remove the vinyl cover by grasping or pulling on the skirting or cover lock straps. The skirting will tear, and torn skirting is not covered under the terms of the warranty.

Check for ice build-up around the gas springs and pivot points of the retractable cover system. Ice buildup may damage system components.

⚠ WARNING: The vinyl cover and retractable cover system are not recommended for use in wind conditions reaching above 25 mph (40 kmh).

IMPORTANT: If your spa is located in an area susceptible to high winds, additional coverlock straps may be installed to minimize wind damage to the cover.

1. With the cover lock straps unfastened, place one hand under the cover skirting, between the spa and cover, to break the cover's vacuum seal. Then, fold the front half of the cover over onto the back half.
2. If no rear access is available, stand to the side of the spa directly adjacent to the hinge area of the folded cover.
 - a. **For the COVERCRADLE retractable cover systems:** Using both hands, cup one hand under the lower half of the cover (just above the water) and place the other along the side of the cover, just above the skirt. Gently push (do not lift) with both hands towards the opposite rear corner of the cover (diagonally). As the cover opens, the gas springs will allow the cover to come to a gentle stop.
 - b. **For the UPRITE retractable cover system:** Simply lift the cover at its center hinge, allowing it to move to the back of the spa and to rest gently there.

- c. **For the LIFT 'N GLIDE retractable cover system:** Slightly lift the cover at front of spa, glide (push back until it stops), fold cover in half and lift cover moving it to the back of the spa. Insert locking pin into side of lifter to prevent accidental closure.

IMPORTANT: When opening a cover with a retractable cover system, only use one of these three specific methods. Do not attempt to open the cover in any other way. Damage caused by improper opening or closing of the cover is not covered under the terms of the limited warranty.

HOW TO CLOSE THE COVER

1. Standing along side the cover, place one hand on the upper corner of the cover and gently push forward in the direction of the spa. The cover will rotate forward to cover half of the spa.
IMPORTANT: For the UPRITE or LIFT 'N GLIDE retractable cover system, disengage the locking mechanism(s) before pushing the cover forward.
2. Unfold the cover by lifting the handle located on the top (front) half of the cover. Allow the unfolded half to fall down onto the spa. The air pressure created by the cover falling will keep the vinyl skirting from being trapped between the cover and the spa shell.

ELECTRICAL REQUIREMENTS

IMPORTANT: Fill the spa with water before turning on the power.

Your **HOT SPRING** spa has been carefully designed to give you maximum safety against electrical shock. Connecting the spa to an improperly wired circuit will negate many of the spa's safety features. Improper wiring may also cause electrocution, risk of fire, and other risks of injuries. Please read and follow the electrical installation requirements and instructions for your specific spa model completely!

All **HOT SPRING** spa models, are equipped with a power indicator (**HOT SPRING** Logo blue light) which, in addition to showing the spa has power to it, has a diagnostic function as well. It will begin blinking if the heater high-limit thermostat has tripped. If the power indicator light is blinking, follow the instructions in the Troubleshooting section to identify and correct the cause. The power indicator will stop blinking once the problem has been corrected. The Power and Ready indicator lights on the control panel also provide the same diagnostic function.

230 VOLT PERMANENTLY CONNECTED MODELS

(**PRISM, PULSE, FLAIR, FLASH & BEAM** 230V only)

HOT SPRING spas must be wired in accordance with all applicable local electrical codes. All electrical work should be done by an experienced, licensed electrician. We recommend the use of appropriate electrical conduit, fittings, and wire for all circuits.

The following diagram illustrates how to wire 230 volt permanently connected spa models:

- An electrical subpanel containing two GFCI breakers is included with each 230 volt spa. We recommend that this subpanel be used to supply power to the spa.
- The subpanel requires a 50 amp, single phase, 230 volt, four wire service (two line, one neutral, one ground). The grounding conductor must not be less than #10 AWG. Refer to local codes and to NEC 250-122 table.
- Mount the subpanel in the vicinity of the spa, but not closer than five feet away, in accordance with all local codes. (N.E.C. 680-38 to 41-A-3)

Once your spa has been filled with water, turn it on and test all of the circuit breakers.

IMPORTANT: If both breakers immediately trip, verify that the wires are correctly connected. Each breaker should be tested prior to each use. Here's how:

1. Push the "TEST" button on each GFCI breaker, and observe it click OFF.
2. Wait 30 seconds, then push the breaker switch to the OFF (down) position (to ensure that it has completely disengaged), then push the breaker switch to the ON (up) position. If you don't wait 30 seconds, the spa's power indicator may continue to blink – try again.

If any of the GFCI breakers fails to operate in this manner, your spa may have an electrical malfunction, and you may be at risk of electrical shock. Turn off all circuits and do not use the spa until the problem has been corrected by an authorized service agent.

⚠ WARNING: Removing, or bypassing any GFCI breaker will result in an unsafe spa and will void the spa's warranty.

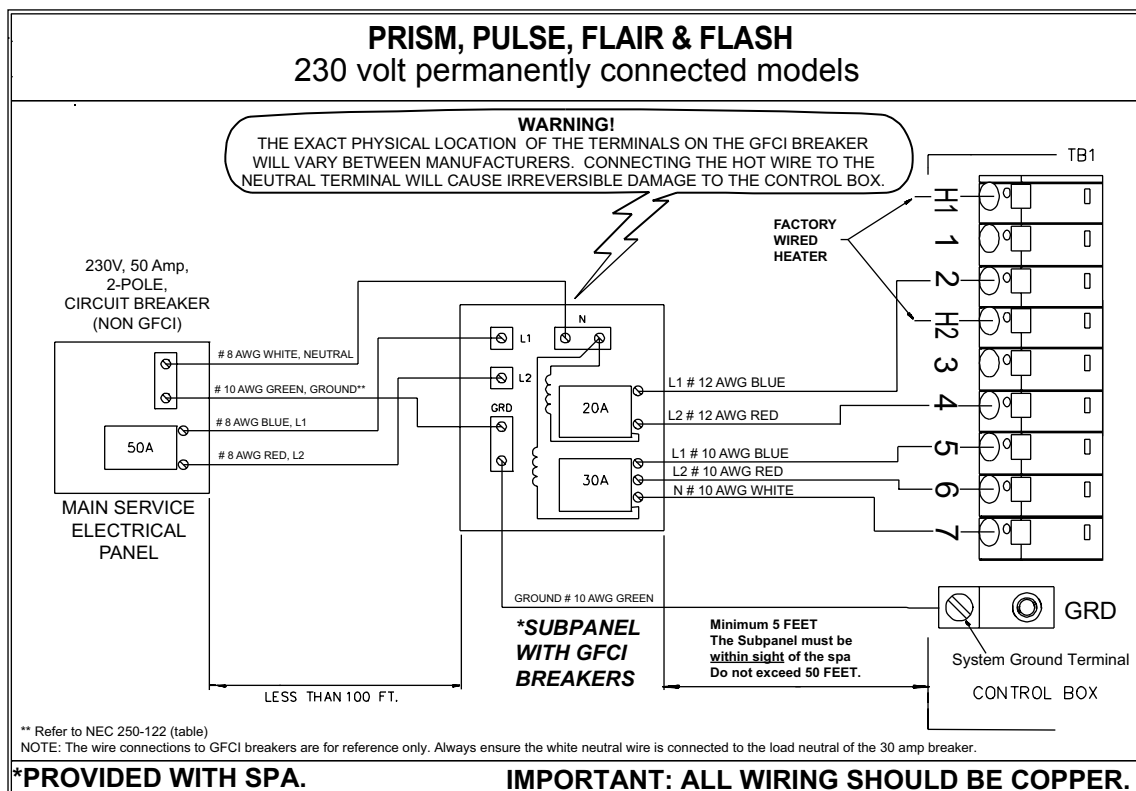

BEAM II 230 volt permanently connected model

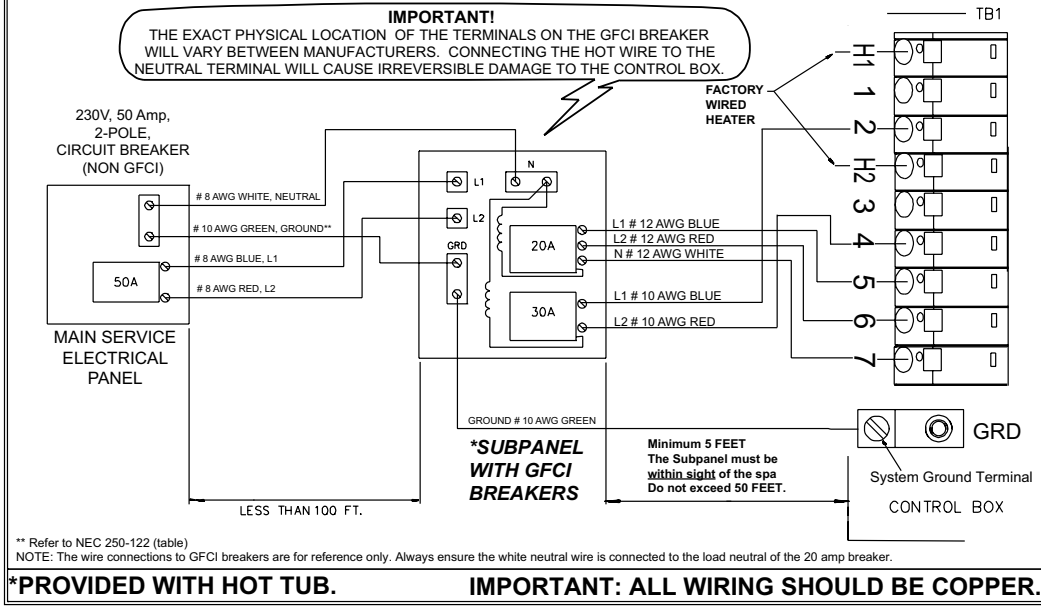

230 VOLT CONVERTED PRISM

The **PRISM** will require an additional 20 amp breaker in order to operate the heater and jet pump 3 at the same time. Without the additional 20 amp breaker, the heater will NOT operate while the jets are used with jet pump 3 on.

This subpanel requires a 70 amp, single phase, 230 volt, four wire service (two line, one neutral, one ground). The ground wire must never be less than #10 AWG. Use NEC 250-122 (table) and local codes for more information. A minimum #6 AWG solid copper bond wire is also required.

Mount the subpanel in the vicinity of the spa, but not within five feet, in accordance with local codes.

HOT SPRING SPAS MUST BE WIRED IN ACCORDANCE WITH ALL APPLICABLE LOCAL ELECTRICAL CODES. ALL ELECTRICAL WORK SHOULD BE DONE BY AN EXPERIENCED LICENSED ELECTRICIAN. WE RECOMMEND THE USE OF APPROPRIATE ELECTRICAL CONDUIT, FITTINGS, AND WIRE FOR ALL CIRCUITS.

IMPORTANT: Service Technician must reconfigure spa using the soft jumpers to allow spa heater to run concurrent with jet pump.

NOTE: Long wiring runs may require larger-gauge wire than stated.

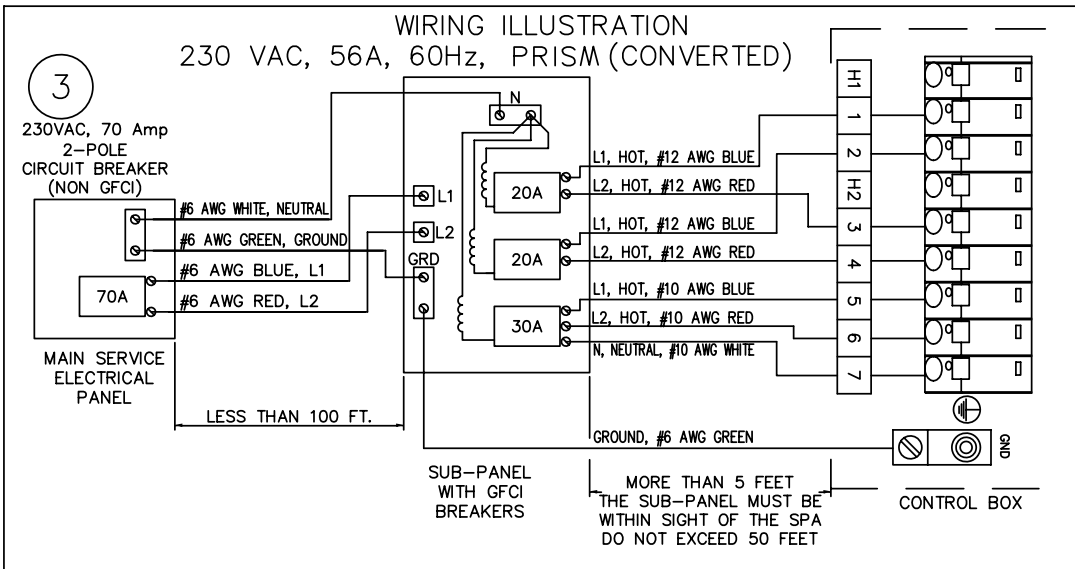

CAUTIONS

USE COPPER CONDUCTORS ONLY
USE SUPPLY WIRES SUITABLE FOR 75°C/167°F.
DISCONNECT ALL SUPPLY CONNECTIONS BEFORE SERVICING.
CONNECT ONLY TO A CIRCUIT PROTECTED BY A CLASS A GROUND-FAULT INTERRUPTER.

THESE SPAS ARE INTENDED FOR USE WITH GFCI SUBPANEL PROVIDED.
ALL CANADIAN SPA MODELS USE #8 AWG GREEN, GROUND.
INCORRECT WIRING WILL DAMAGE CIRCUIT BOARDS.
REFER TO THE WIRING INSTRUCTIONS INCLUDED WITH THE SUB-PANEL FOR DETAILED WIRING INSTRUCTIONS.

115 VOLT GFCI BEAM (MODEL BMI)

The Ground Fault Circuit Interrupter (GFCI) is a safety device that is designed to detect as little as 5 milliamps ($\pm 1\text{mA}$) of electrical current leakage to ground. **WATKINS WELLNESS** recommends that the GFCI be tested prior to each use to ensure it is functioning correctly. With the spa connected to the power supply, push the "Test" button. The spa should stop operating and the GFCI power indicator will go out. Wait 30 seconds and then reset the GFCI by pushing the Reset button. The GFCI power indicator will turn on, restoring power to the spa. If the interrupter does not perform in this manner, it is an indication of an electrical malfunction and the possibility of an electric shock. Disconnect the plug from the receptacle until the fault has been identified and corrected.

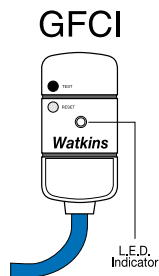

IMPORTANT: Failure to wait 30 seconds before resetting the GFCI may cause the spa's Power indicator (on the control panel) to blink. If this occurs, repeat the GFCI test procedure.

Never use the GFCI as a means to disconnect power to the spa (always unplug it). If the GFCI is tripped while the spa is plugged in, and a power outage occurs, when power returns the GFCI will automatically reset and power will flow to the spa.

115 VOLT OPERATION (60Hz ONLY)

The spa must be connected to a dedicated 115 volt, 20 amp, GFCI protected, grounded circuit. The term "dedicated" means the electrical circuit is not being used or shared for any other electrical items (patio lights, appliances, garage circuits, etc.). If the spa is connected to a non-dedicated circuit, overloading will result in "nuisance tripping" at the main panel. This requires frequent resetting of the breaker switch at the house electrical breaker panel and introduces the possibility of damage or failure of spa equipment. The dedicated circuit must be properly wired; that is, it must have a 20-amp GFCI circuit breaker in the house breaker panel, #12 AWG or larger wire (including the ground wire) and the correct polarity throughout the circuit.

NEVER CONNECT THE SPA TO AN EXTENSION CORD!

A pressure wire connector is provided on the exterior surface of the control box, inside the spa. This is to permit the connection of a ground bonding wire between this point and any metal equipment, enclosures, reinforced concrete pad, pipe, or conduit within 5 feet of the spa (if needed to comply with local building code requirements). The bonding wire must be at least a #10-AWG solid copper wire. Bond the spa to all exposed metal equipment or fixtures, handrails, and concrete pad per N.E.C. Article 680 and all local codes.

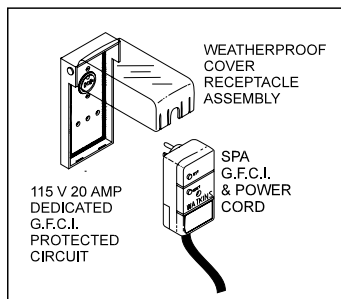
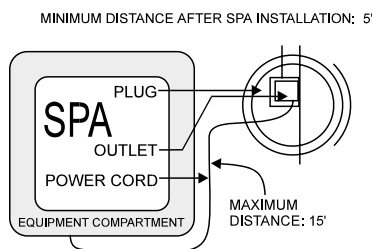

INSTALLATION INSTRUCTIONS

All 115 volt **BEAM (MODEL BMI)** come equipped with approximately 15 feet of useable power cord (this is the maximum length allowed by Underwriters Laboratory and the National Electric Code). When the spa is installed, the power cord will come out of the bottom of the equipment compartment door. For your safety, when the electrician is installing the 20 amp single electrical outlet and waterproof cover, the outlet should be no closer than 5 feet (1.5 meters) and no farther than 10 feet from the spa [reference National Electrical Code 680-6a(1) and 680-41a].

The Ground Fault Circuit Interrupter (GFCI) is located at the end of the power cord. This device is for your protection. It is very important to protect it from rain and other moisture. Test once a month, with the plug connected to the power supply,

1. Push the "TEST" button on the GFCI breaker. The spa should stop operating and the GFCI power indicator will go out.
2. Wait 30 seconds, then push the "RESET" button. Power will be restored to the spa and the GFCI power indicator will turn on.

If the GFCI fails to operate in this manner, your spa may have an electrical malfunction, and you may be risking electrical shock. Turn off all circuits and do not use the spa until the problem has been corrected by an authorized service agent.

⚠️ WARNING: Removal of the GFCI from the spa's power cord will result in an unsafe spa and will void the spa's warranty.

IMPORTANT: Should you ever find the need to move or relocate your **HOT SPRING** spa, it is essential that you understand and apply these installation requirements. Your **HOT SPRING** spa has been carefully engineered to provide maximum safety against electric shock. Remember, connecting the spa to an improperly wired circuit will negate many of its safety features.

ADVANTAGE TO HAVING YOUR SPA CONVERTED

- In the 115 volt configuration, either the heater, or the jet pump can operate, but they can't work at the same time. In a 115 volt system, as long as the jet pump is activated, the heater will not turn on. On the other hand, when the spa is converted to operate in the 230 volt configuration, the heater and jet pump can operate simultaneously.
- The heater will operate at 1500 watts when the spa is configured as a 115 volt cord-and-plug connected model, and at 6000 watts when the spa is configured as a 230 volt converted model heating your spa water faster.

115/230 VOLT CONVERTIBLE MODEL

The **BEAM** model BMI can be converted to 230 volt operation with the addition of a subpanel and a control box wiring change. Consult your dealer before attempting to convert from 115 volt operation to 230 volt operation. Any damage to the spa from improper conversion is not covered under the warranty.

230 VOLT CONVERTED BEAM

HOT SPRING spas must be wired in accordance with all applicable local electrical codes. All electrical work should be done by an experienced, licensed electrician. We recommend the use of appropriate electrical conduit, fittings, and wire for all circuits.

Refer to the following instructions to convert from 115 volt to 230 volt

IMPORTANT: Converting the spa to 230 volt operation will require both an authorized **HOT SPRING** service agent and a qualified electrician.

Required Part: A Subpanel (230 volt Convertable) available from your **HOT SPRING** dealer.

1. Disconnect the power cord from the house receptacle.
2. Open the equipment compartment door.
3. Remove the screws on the front of the spa control box.
4. Open the control box cover.
5. Identify Terminal block located in the lower left-hand corner inside the control box.
6. Refer to illustration, Step 1. Remove the 2 pin jumper attached to terminals 4 and 5.
7. Refer to illustration, Step 1. Remove the wire jumper from terminals 2, and 6.
8. Refer to illustration, Step 2. Remove the power cord wires from 5, 7 and GRD (not illustrated).
9. Unscrew the power cord strain relief and remove the power cord from the access hole in the control box.

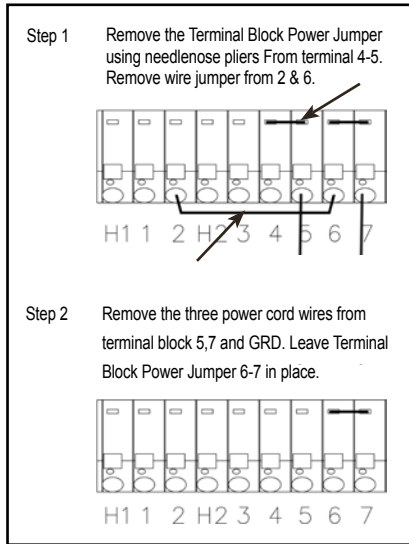

Converting from 115 volts to 230 volts changes the voltage supplied to the heater from 115-volts to 230 volts. The jet pump will continue to operate at 115 volts.

Have your licensed electrician wire subpanel from a 50A Main Service, then from subpanel into the spa's control box using the following illustration or use the wire diagram on the inside of the control box lid.

IMPORTANT: The subpanel must be placed in sight of the spa, at a minimum distance of 5 feet away.

WIRING CONNECTIONS

IMPORTANT: Fill the spa with water before turning on the power

- Once your spa has been filled with water, turn it on and test all the circuit breakers.

Each breaker should be tested prior to each use. Here's how:

1. Push the "TEST" button on each GFCI breaker, and observe it click off.
2. Wait 30 seconds, then push the breaker switch to the OFF (down) position (to ensure that it has completely disengaged), then push the breaker switch to the ON (up) position. If you don't wait 30 seconds, the spa's power indicator may continue to blink – try again.

If any of the GFCI breakers fails to operate in this manner, your spa may have an electrical malfunction, and you may be risking electrical shock. Turn off all circuits and do not use the spa until the problem has been corrected by an authorized service agent.

IMPORTANT: Service Technician must reconfigure spa using the soft jumpers to allow spa heater to run concurrent with jet pump.

⚠ WARNING: Do not allow pliers to contact any electronic components inside the control box.

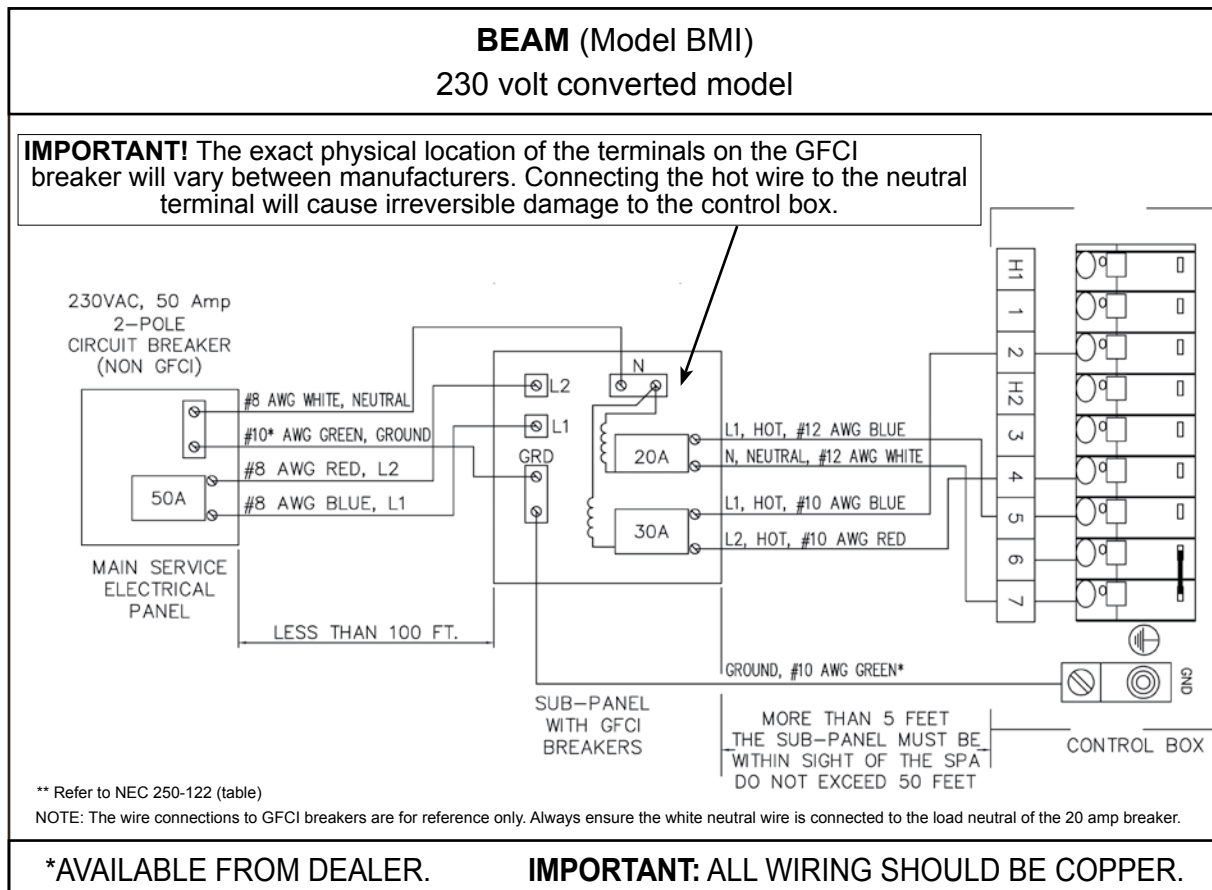

SERVICE INFORMATION

GENERAL INFORMATION

Your **HOT SPRING** spa has been designed to provide years of trouble-free use. As with any appliance, problems may occasionally occur that require the expertise of a qualified service person. Though such simple repairs as resetting a GFCI switch or breaker, or resetting a high limit thermostat may not require a service call, they may indicate that a more serious condition exists. These conditions may require an experienced service person. Before calling for service, please refer to the Troubleshooting Guide. Always retain your original sales receipt for future reference.

GFCI AND HIGH LIMIT THERMOSTAT

If your spa fails to operate at any time, first check the power supply to the spa.

Check each of the GFCI breakers in the subpanel. If a GFCI has tripped, reset it. If it will not reset, this may be an indication of a ground fault (short circuit) within the electrical components. Contact an Authorized Service Technician for a complete diagnosis.

If upon checking the GFCI's you find that they have not tripped, check the house breaker panel and ensure the main breaker for the electrical circuit supplying the spa has not tripped. If it has, this is an indication that the circuit was either overloaded or a ground fault exists between the breaker panel and the spa receptacle or subpanel. Contact a qualified electrician.

If upon checking the main house breaker and spa GFCI's you find no failures, check the high limit thermostat. To check it, simply turn off power to the spa for 30 seconds. This will automatically reset the high limit thermostat if it has tripped. If the spa energizes once you turn the power back on, this indicates reduced water flow through the heating system. Tripping of the high limit thermostat is normally a result of one or a combination of these problems: 1) clogged filter cartridge(s), 2) blockage within the system plumbing, 3) a non-functioning heater circulation pump, 4) power was not disconnected from the spa before it was drained, 5) an air lock in the plumbing lines. (The Power Indicator on the front of the spa's control panel will also be blinking if the high limit thermostat circuit has tripped.)

If the spa does not function after tripping and resetting the GFCI's or resetting the high limit thermostat, then the problem should be referred to an Authorized Service Technician. Refer to the Heater section if the spa operates but does not heat, or refer to the Troubleshooting Guide for additional service information.

NO-FAULT HEATER AND INTEGRATED PRESSURE SWITCH

WATKINS WELLNESS unconditionally warrants the **NO-FAULT** heater against any failure that would require replacement. This warranty's duration is equal to the time period identified in the Component Warranty. This warranty defines unconditional as warranty coverage without exception provided that the component has failed to operate properly within the spa's system. This means that conditions that would normally invalidate the limited warranty, such as water chemistry damage, do not apply to the **NO-FAULT** heater.

It is important to note that the **NO-FAULT** heater is protected by both the heater high limit thermostat circuit and the integrated pressure switch. The causes of heater high limit tripping are discussed in the previous section.

If the spa is not heating, the red and green lights are blinking, but the pump and light are operating, then the pressure switch may be open. Opening of the pressure switch is normally a result of one or a combination of these problems:

1. A clogged filter cartridge
2. Blockage within the system plumbing
3. Power was not disconnected to the spa before it was drained
4. An air lock in the plumbing lines

Once the problem has been identified and corrected the pressure switch will close which will energize the heater.

SILENT FLO 5000 CIRCULATION PUMP AND CIRCULATION PUMP THERMAL CUT-OFF

The **HOT SPRING SILENT FLO 5000** circulation pump is a dedicated, water cooled, energy efficient, quiet pump that provides continuous filtration for the spa. Since the **SILENT FLO 5000** pump is water cooled, it is equipped with a thermal cut-off to prevent the pump from being damaged by running hot when water is not present.

Reset the circulation pump's thermal cut-off by disconnecting power to the spa and allowing the pump to cool.

Tripping of the thermal cut-off is normally the result of one or a combination of these problems: 1) clogged filter cartridge(s), 2) blockage within the system plumbing, 3) power was not disconnected to the spa before it was drained, or 4) an air lock in the plumbing lines. Once the problem has been identified and corrected the pump thermal cut-off will be able to be reset which will allow it to operate normally.

MISCELLANEOUS SERVICE INFORMATION

The control and high-limit thermostats are equipped with electronic sensors that are connected to the spa's plumbing. Never cut or kink the wires that connect the sensors to the thermostats within the control box.

The jet pump is equipped with a thermal overload cutoff switch that is designed to protect the pump from overheating. If the pump shuts itself off in an older spa, it could indicate failure of the pump motor bearings. If the pump shuts itself off in a new spa, it is usually the result of one or a combination of the following factors:

- Thermal overload: Although mass-produced, not all thermal overload cutoffs are exactly the same. Some are more sensitive than others and will shut the pump off at lower temperatures.
- High temperature: All **HOT SPRING** spa models are equipped with a jet pump shroud that vents the heat generated by the pump motor to the outside of the equipment compartment, and back into the spa water. If the vent is blocked by masonry, grass or debris, overheating of the jet pump may occur. Once the pump motor has cooled sufficiently and any blockage has been removed from the vent opening, the jet pump can be restarted.
- Friction: Sometimes the moving parts of a new pump are tight enough to cause heat build-up due to friction. After a normal break-in period, the pump will run cooler.
- Improper wiring: If the spa is connected with an extension cord, and/or the house wiring is undersized, the pump may starve for voltage and therefore may draw more amperage and generate excessive heat.

- If the pump is shutting down due to excessive heat, make sure the equipment compartment has adequate ventilation. The air gap at the bottom must not be blocked. Should your jet pump continue to shut off after short periods of use, contact a qualified service technician.

ACTS INVALIDATING WARRANTY

The limited warranty is void if the **HOT SPRING** spa has been improperly installed, subjected to alteration, misuse, or abuse, or if any repairs on the spa are attempted by anyone other than an authorized representative of **WATKINS WELLNESS**. Alteration shall include any component or plumbing change, electrical conversion, or the addition of any non-approved sanitation or water purification device, or heating system which contributes to component or unit failure or unsafe operating system. Misuse and abuse shall include any operation of the spa other than in accordance with **WATKINS WELLNESS** printed instructions, or use of the spa in an application for which it is not designed; specifically: use of the spa in a non-residential application; damage caused by operation* of the spa at water temperatures outside the range of 35°F (1.7°C) and 120°F (49°C); damage caused by a dirty, clogged or calcified filter cartridge; damage to the spa surface caused by the use of tri-chloro chlorine, BCDMH, chemical tablets in a floater, acid, or any other spa chemicals or spa surface cleaners which are not recommended by **WATKINS WELLNESS**; damage caused by allowing undissolved spa sanitizing chemicals to lie on the spa surface (no spa surface material can withstand this kind of abuse); damage to components or spa surface caused by improper water chemistry maintenance; and damage to the spa surface caused by leaving the spa uncovered while empty of water and in direct exposure to sunlight (this may cause solar heating distress in warm weather regions). These are considered abuses and may invalidate this warranty.

Acts of nature, and damage caused by animals, rodents, and insects are considered abuses and are not covered under this warranty.

*Operation of the spa does not mean "use" of the spa! **WATKINS WELLNESS** does not recommend using the spa if the water temperature is above or below the spa's control panel temperature range.

DISCLAIMERS

WATKINS WELLNESS shall not be liable for loss of use of the **HOT SPRING** spa or other incidental, consequential, special, indirect, or punitive costs, expenses or damages, which may include but are not limited to the removal of a permanent deck or other custom fixture or the necessity for crane removal. Any implied warranty shall have a duration equal to the duration of the applicable limited warranty stated above. Some states do not allow limitations on how long an implied warranty lasts. Under no circumstances shall **WATKINS WELLNESS** or any of its representatives be held liable for injury to any person or damage to any property, however arising.

Some states do not allow the exclusion or limitation of incidental or consequential damages, so the above limitations may not apply to you.

WATKINS WELLNESS CUSTOMER SERVICE

If you have any questions about any aspect of your **HOT SPRING** spa set-up, operation or maintenance that have not been answered by this manual, consult your **HOT SPRING** dealer.

WATKINS WELLNESS can be reached at: 800-999-4688 (Extension 8432), Monday through Friday, 8 am to 5-pm Pacific Standard Time (PST), or e-mail customerservice@watkinsmfg.com.

TROUBLESHOOTING

Should you experience any problem whatsoever, do not hesitate to contact your authorized **HOT SPRING** dealer. On the following page are some tips to help you to diagnose and rectify some more common sources of trouble, if you choose to do so.

TROUBLESHOOTING

Should you experience any problem, do not hesitate to contact your authorized **HOT SPRING** dealer. Here are some tips to help you to diagnose and rectify some more common sources of trouble yourself, if you choose to do so.

GENERAL OPERATION TROUBLESHOOTING GUIDE		
Problem	Probable causes	Solutions
Entire spa is inoperative	<ul style="list-style-type: none"> Power failure GFCI tripped Heater high-limit thermostat tripped Spa lock activated 	<ul style="list-style-type: none"> Check power source Reset GFCI; call for service if it will not reset Disconnect power for at least thirty seconds to reset heater high limit. If it will not reset, check for clogged filters. If tripping continues, call for service. Deactivate spa lock
Spa does not heat; jets and light operate	<ul style="list-style-type: none"> Integrated pressure switch open Circulation pump thermal cut-off tripped 	<ul style="list-style-type: none"> Check for clogged filters. Integrated pressure switch will reset when the flow of water through the heater has been restored. Call for service if the heater trips frequently. Check for clogged filters or air locks in plumbing. Disconnect power to the spa, allow circulation pump to cool. Circulation pump thermal cut-off will reset when pump has cooled and power is reapplied. Call for service if circulation pump thermal cut-off trips frequently.
Jets weak or surging	<ul style="list-style-type: none"> Spa water level too low Filters clogged COMFORT CONTROL lever closed 	<ul style="list-style-type: none"> Add water Clean filters Open COMFORT CONTROL lever
Light inoperative	<ul style="list-style-type: none"> Spa lock activated Light wiring or assembly is faulty 	<ul style="list-style-type: none"> Deactivate spa lock Replace light assembly
Ready indicator icon is flashing	<ul style="list-style-type: none"> Temperature sensor problem 	<ul style="list-style-type: none"> Disconnect power for at least thirty seconds. If blinking continues, call for service.

LOGO LIGHT TROUBLESHOOTING GUIDE					
ALERT	POWER	READY	STATUS	SPA STATE / ACTION	LCD Message
Spa is Ready	Blue On	Green On	Green On	Temperature within +/- 2 degrees F, Heater Available, Salt System Functioning*	
Spa is not Ready	Blue On	OFF	Green On	Temperature not within +/- 2, Heater Available, Salt System Functioning*	
Check Salt System	Blue On	Green On/Off	Yellow On	Salt System reminders. Salt System remains functioning*	(On Salt Screen)
Salt System Alerts-Offline	Blue On	Green On/Off	Yellow Flash	Salt System Fault or Offline/Not Functioning (Low/High salt, Salt System Fault)*	(On Salt screen)
No Flow Fault Pressure Sw Error	Blue On	Green On/Off	Yellow Flash	Heater off – Control Panel => Check and Clean Filter, => Call for Service if necessary	E2: NO FLOW-CHECK FILTER
Cool Zone Fault-Heat Only	Blue On	Green On/Off	Yellow Flash	Cool Zone detected, but reporting internal fault. Spa uses own heater only* => Call for Service	E4: PERIPHERAL FAULT
Accessories Fault	Blue On	Green On/Off	Yellow Flash	Accessories power off, fault detected. No Salt System, no music, no lights => Call for Service	E11-16: COOL ZONE OFFLINE
Protection Mode	Red FLASH	Red FLASH	Red FLASH	High Limit fault, heater relay fault, internal fault detected (Heater, Jets off, Circulation on) => Call for Service	(Protection Mode Screen)
Control Sensor Fault	Blue On	OFF	Red FLASH	Heater off => Call for Service	E5: SENSOR FAULT
Heater Power Fault	OFF	Green On/Off	Yellow Flash	Heater off- No power detected => Call for Service	E6: NO HEATER PWR
Logo Comm Fault	White	White	White	If Logo communication error. <i>Spa status not known!</i> Call for Service	
Power Up	Red	Red	Red	Steps thru Red-Green-Blue-White color sequence at power up.	
	Green	Green	Green		
	Blue	Blue	Blue		
	White	White	White		

*Status shown only if accessory is installed

SPA WATER MAINTENANCE TROUBLESHOOTING GUIDE

Problem	Probable causes	Solutions
Cloudy Water	<ul style="list-style-type: none"> • Dirty filters • Excessive oils / organic matter • Improper sanitization • Suspended particles / organic matter • Overused or old water 	<ul style="list-style-type: none"> • Clean filters • Shock spa with sanitizer • Add sanitizer • Adjust pH and/or alkalinity to recommended range • Run jet pump(s) and clean filters • Drain and refill the spa
Water Odor	<ul style="list-style-type: none"> • Excessive organics in water • Improper sanitization • Low pH 	<ul style="list-style-type: none"> • Shock spa with sanitizer • Add sanitizer • Adjust pH to recommended range
Chlorine Odor	<ul style="list-style-type: none"> • Chloramine level too high • Low pH 	<ul style="list-style-type: none"> • Shock spa with sanitizer • Adjust pH to recommended range
Musty Odor	<ul style="list-style-type: none"> • Bacteria or algae growth 	<ul style="list-style-type: none"> • Shock spa with sanitizer—if problem is visible or persistent, drain, clean and refill the spa
Organic buildup / scum ring around spa	<ul style="list-style-type: none"> • Build-up of oils and dirt 	<ul style="list-style-type: none"> • Wipe off scum with clean rag – if severe, drain the spa, use a spa surface and tile cleaner to remove the scum, and refill the spa
Algae Growth	<ul style="list-style-type: none"> • High pH • Low sanitizer level 	<ul style="list-style-type: none"> • Shock spa with sanitizer and adjust pH • Shock spa with sanitizer and maintain sanitizer level
Eye Irritation	<ul style="list-style-type: none"> • Low pH • Low sanitizer level 	<ul style="list-style-type: none"> • Adjust pH • Shock spa with sanitizer and maintain sanitizer level
Skin Irritation / Rash	<ul style="list-style-type: none"> • Unsanitary water • Free chlorine level above 5 ppm 	<ul style="list-style-type: none"> • Shock spa with sanitizer and maintain sanitizer level • Allow free chlorine level to drop below 5 ppm before spa use
Stains	<ul style="list-style-type: none"> • Total alkalinity and/or pH too low • High iron or copper in source water 	<ul style="list-style-type: none"> • Adjust total alkalinity and/or pH • Use a metal deposit inhibitor
Scale	<ul style="list-style-type: none"> • High calcium content in water – total alkalinity and pH too high 	<ul style="list-style-type: none"> • Adjust total alkalinity and pH – if scale requires removal, drain the spa, scrub off the scale, refill the spa and balance the water

SPA SPECIFICATIONS

Spa Model	Footprint Dimension	Height	Effective Filter Area	Heater (Watts)	Water Capacity	Dry Weight	Filled Weight*	Dead Weight*	Electrical Requirements
PRISM (Model PSM) Seats 7 Adults	9'2" x 7'7" 2.79 m x 2.31 m	38" 97 cm	150 square feet	4,000	525 gallons 1,990 liters	1,190 lbs. 540 kg	6,795 lbs. 3,085 kg	120 lb/ft ² 585 kg/m ²	230 volt, 50 or 70 amp Single phase GFCI protected circuit
PULSE (Model PLS) Seats 7 Adults	7'5" x 7'5" 2.26 m x 2.26 m	38" 97 cm	100 square feet	4,000	445 gallons 1,685 liters	1,015 lbs. 460 kg	5,950 lbs. 2,700 kg	130 lb/ft ² 635 kg/m ²	230 volt, 50 amp Single phase GFCI protected circuit
FLAIR (Model FLR) Seats 6 Adults	7'0" x 7'0" 2.13 m x 2.13 m	36" 91 cm	100 square feet	4,000	335 gallons 1,270 liters	875 lbs. 400 kg	4,720 lbs. 2,140 kg	120 lb/ft ² 585 kg/m ²	230 volt, 50 amp Single phase GFCI protected circuit
FLASH (Model FSH) Seats 7 Adults	7'0" x 7'0" 2.13 m x 2.13 m	36" 91 cm	100 square feet	4,000	360 gallons 1,365 liters	845 lbs. 385 kg	5,070 lbs. 2,300 kg	125 lb/ft ² 610 kg/m ²	230 volt, 50 amp Single phase GFCI protected circuit
BEAM (Model BMII) Seats 4 Adults	6'8" x 6'8" 2.03 m x 2.03 m	33" 84 cm	100 square feet	6,000	295 gallons 1,115 liters	700 lbs. 320 kg	3,860 lbs. 1,750 kg	110 lb/ft ² 540 kg/m ²	230 volt, 50 amp Single phase GFCI protected circuit
BEAM (Model BMI) Seats 4 Adults	6'8" x 6'8" 2.03 m x 2.03 m	33" 84 cm	100 square feet	1,500 or 6,000	295 gallons 1,115 liters	700 lbs. 320 kg	3,860 lbs. 1,750 kg	110 lb/ft ² 540 kg/m ²	115 volt, 20 amp dedicate GFCI protected circuit OR 230 volt, 50 amp Single phase GFCI protected circuit

 **WARNING: WATKINS WELLNESS** suggests a structural engineer or contractor be consulted before the spa is placed on an elevated deck.

* IMPORTANT: The "Filled weight" and "Dead weight" of the spa includes the weight of the occupants (assuming an average occupant weight of 175lbs).



This manual contains installation, operating, maintenance and service information for the following 2021 **HOT SPRING** spa models:

USA MODEL	EFFECTIVE DATE
PRISM (MODEL PSM)	10/20
PULSE (MODEL PLS)	10/20
FLAIR (MODEL FLR)	10/20
FLASH (MODEL FSH)	10/20
BEAM (MODELS BMI/BMII)	10/20

©2020 WATKINS WELLNESS All Rights Reserved. Limelight, Prism, Pulse, Flair, Beam, Flash, No-Fault, IQ 2020, Everwood, Raio, Wavemaster, Silent Flo 5000, CoverCradle, Clean-Screen, Cover Shield, UpRite, Lift 'n Glide, FreshStart, FreshWater, Vidro, FreshWater_{Ag+} and The Home Relaxation Specialists are trademarks of WATKINS WELLNESS. BaquaSpa is a trademark of Arch UK Biocides Limited. iPod is a trademark of Apple, Inc.



WatkinsWellness[®]

Feel good. Live well.

**Vista, California
USA**



hotspring.com

303759.21 A (10/20)